



Ejercicios



Razonamiento Abstracto

Preguntas modelo
examen de acceso a la educación superior

Modelo X



ACCESO a la Educación Superior
SENESCYT

QUIERO SER MAESTRO
Ministerio de Educación

ACCESO A LA EDUCACIÓN SUPERIOR TAE100_001

Opción Múltiple

Elige la opción que complete mejor el enunciado o que responda mejor a la pregunta.

www.riolearning.com

1.

¿Cuál es la figura que falta?

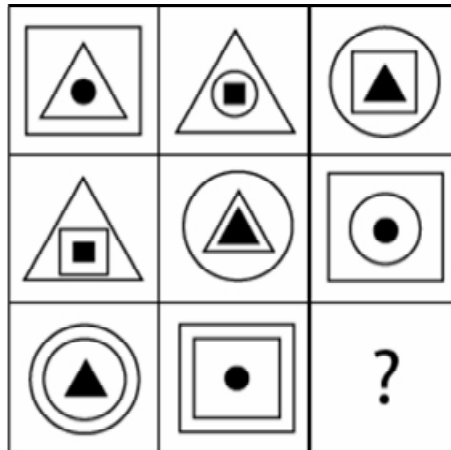

- A.
- B.
- C.
- D.
- E.

www.riolearning.com

2.

¿Cuál es la figura que falta?

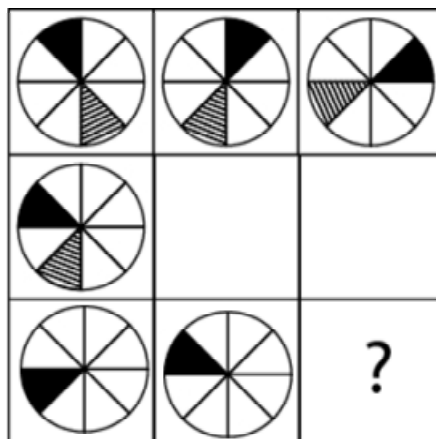

- A.
- B.
- C.
- D.
- E.

3.

¿Cuál es la figura que falta?

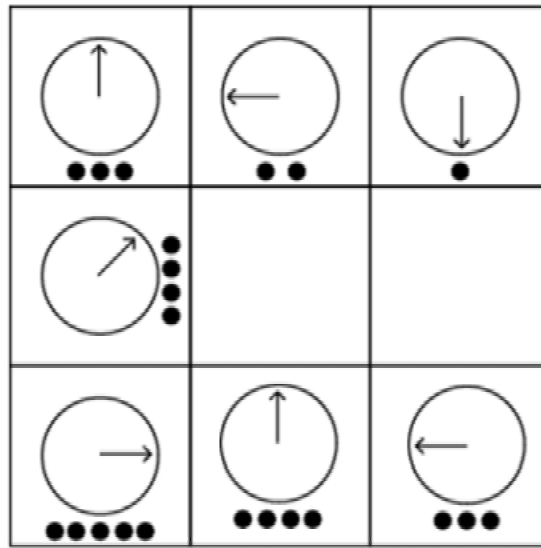

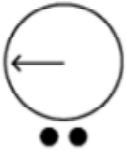
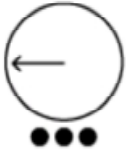
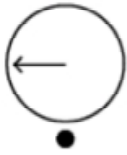
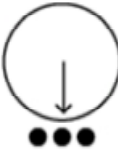
- A.  B.  C.  D.  E. 

4.

¿Cuál es la figura que falta?

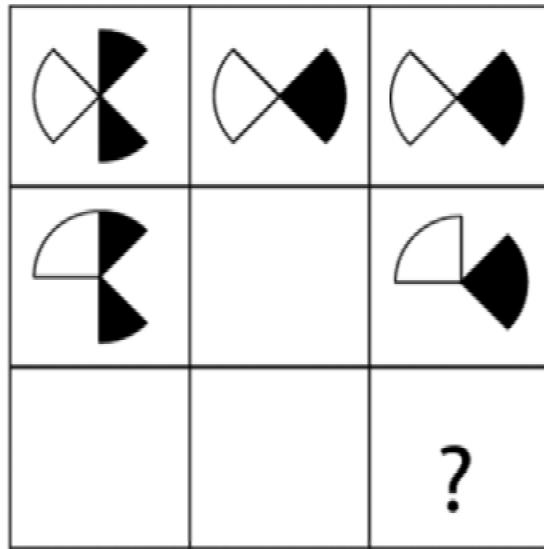



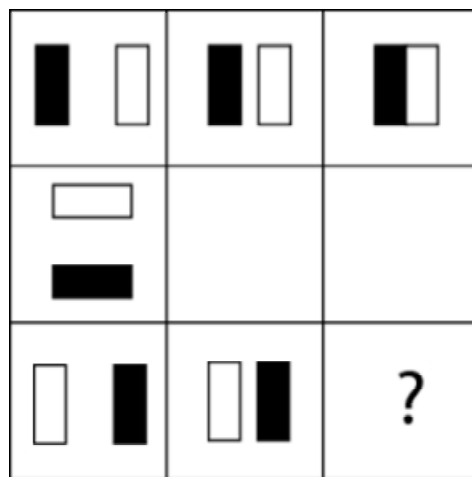

- A.  B.  C.  D.  E. 

5.

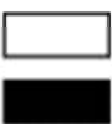
¿Cuál es la figura que falta?





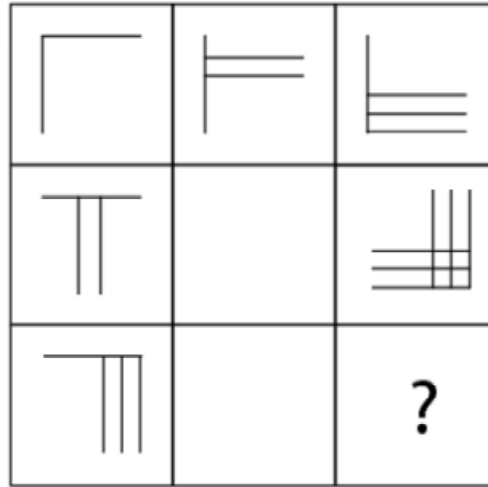

- A.  B.  C.  D.  E. 

6.

¿Cuál es la figura que falta?





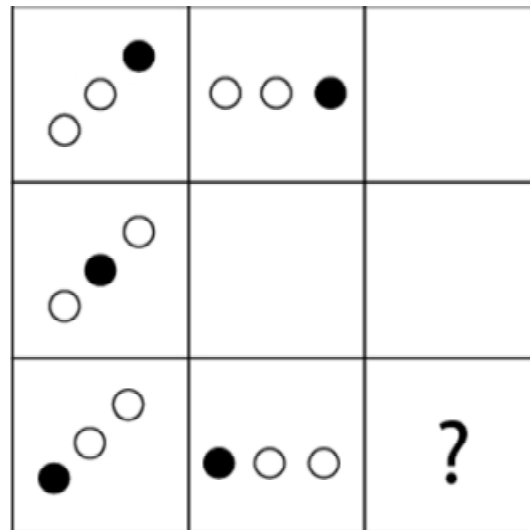

- A.  B.  C.  D.  E. 

7.

¿Cuál es la figura que falta?

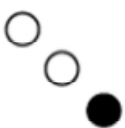

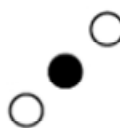



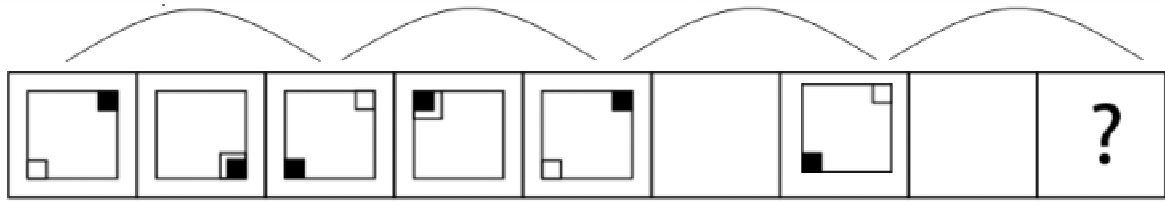

- A.  B.  C.  D.  E. 

www.riolearning.com

8.

¿Cuál es la figura que falta?



A.  B.  C.  D.  E. 

www.riolearning.com

9.

¿Cuál es la figura que falta?

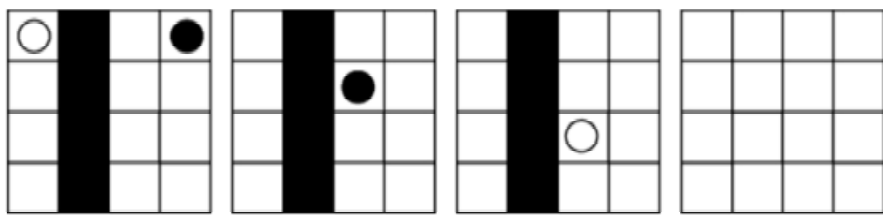

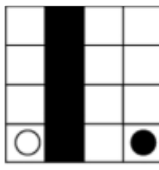
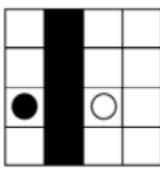
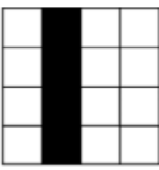
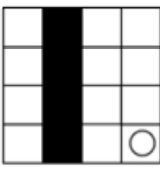
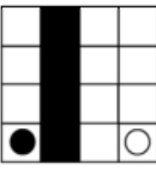



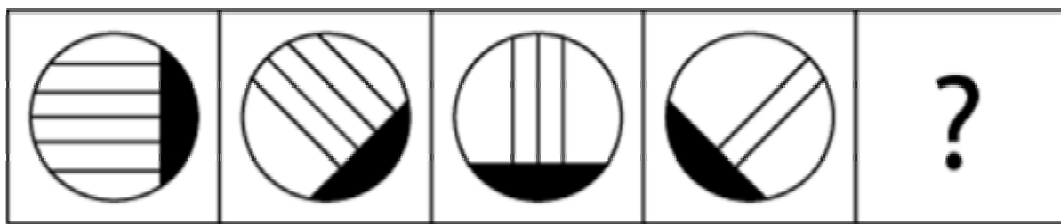

A.  B.  C.  D.  E. 

www.riolearning.com

10.

¿Cuál es la figura que falta?



A.  B.  C.  D.  E. 

11.

¿Cuál es la figura que falta?

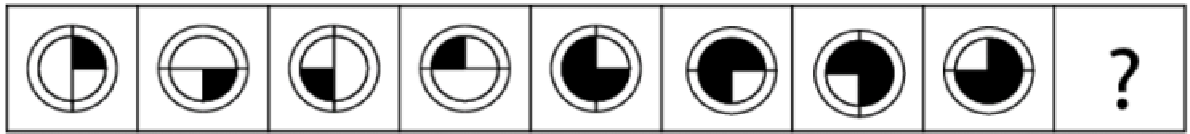

A.



B.



C.



D.



E.



12.

¿Cuál es la figura que falta?

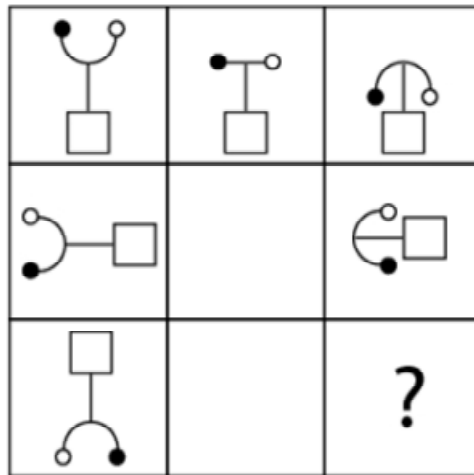

A.



B.



C.



D.



E.



www.riolearning.com

13.

¿Cuál es la figura que falta?

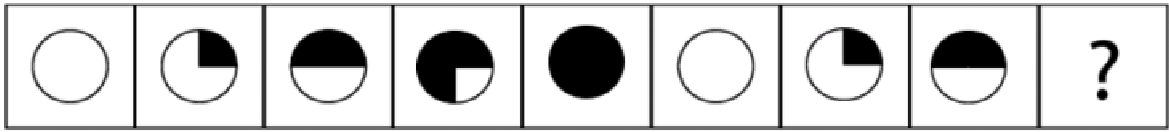

www.riolearning.com

14.

¿Cuál es la figura que falta?

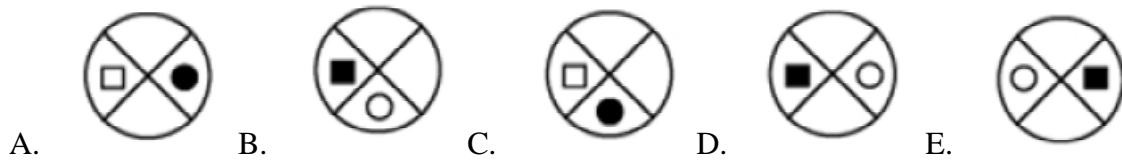
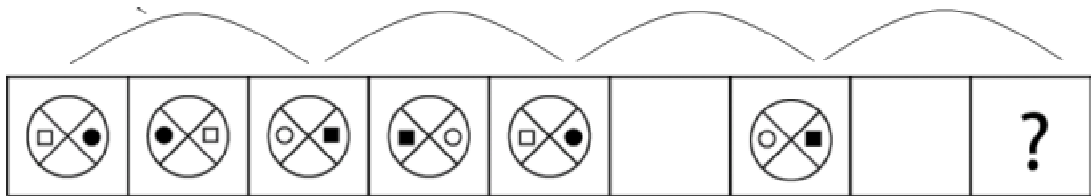

www.riolearning.com

15.

¿Cuál es la figura que falta?

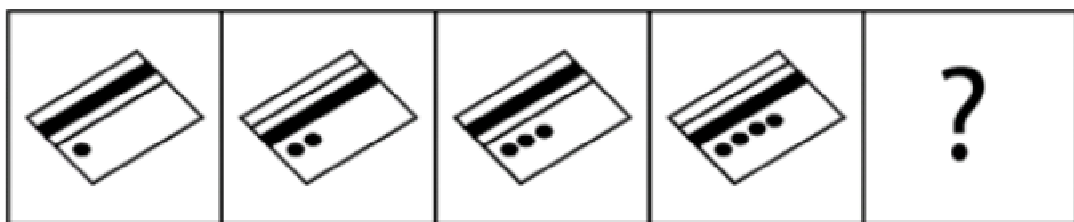

16.

¿Cuál es la figura que falta?

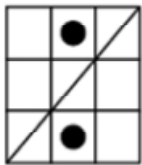
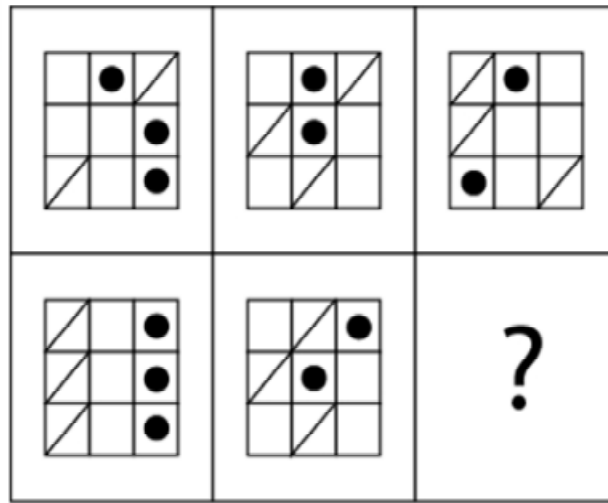

A.

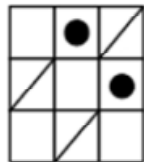

B.

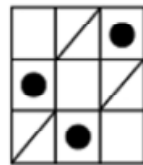

C.

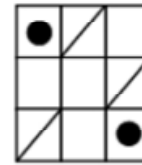

D.

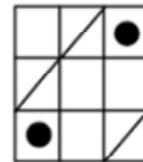

E.

17.

¿Cuál es la figura que falta?

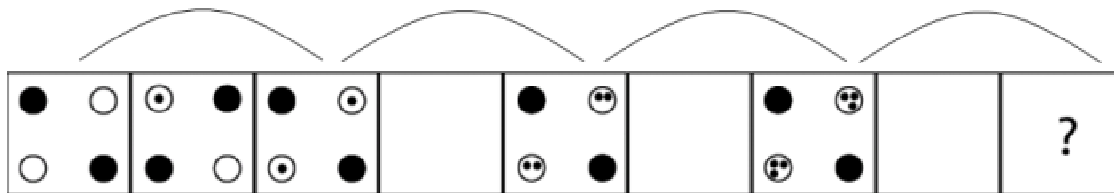

A.



B.



C.



D.



E.

www.riolearning.com

18.

¿Cuál es la figura que falta?

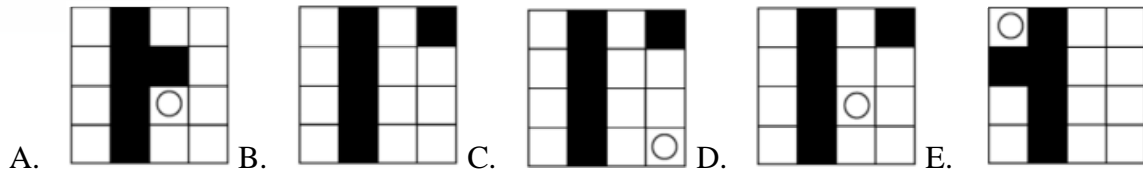
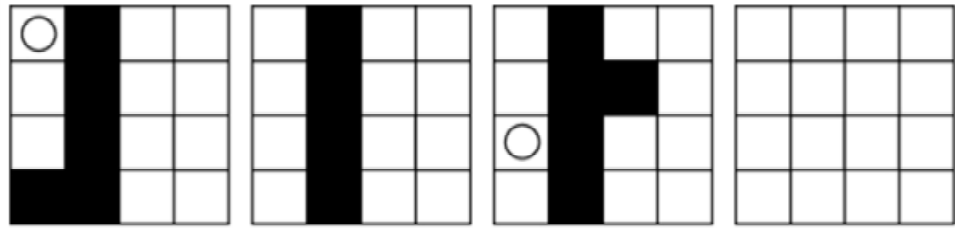

www.riolearning.com

19.

¿Cuál es la figura que falta?

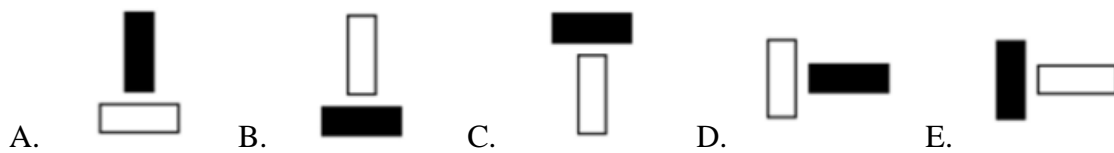
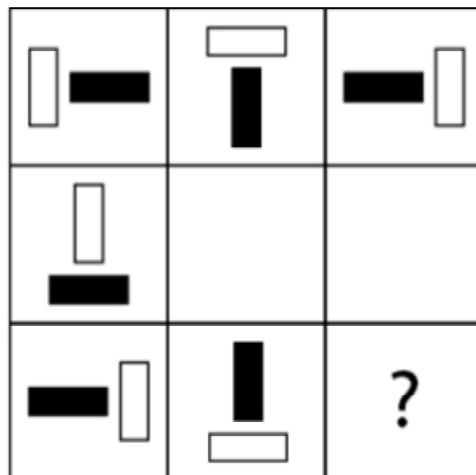



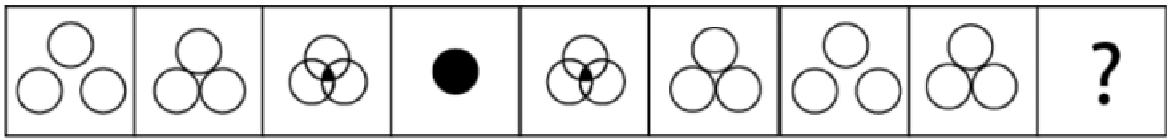

www.riolearning.com

20.

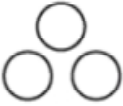
¿Cuál es la figura que falta?



- A.  B.  C.  D.  E. 

www.riolearning.com

21.

¿Cuál es la figura que falta?

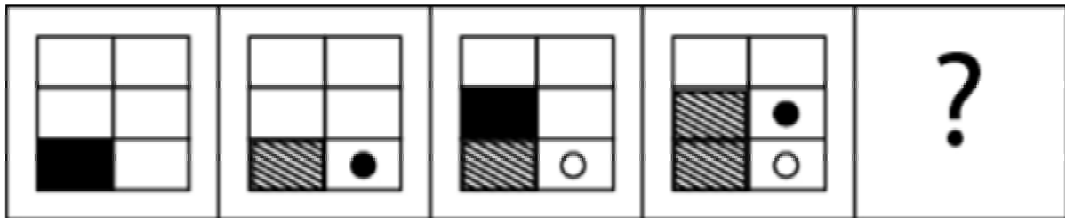

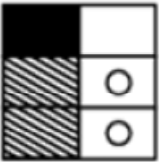
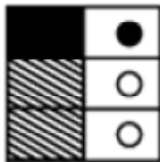
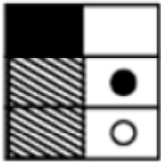
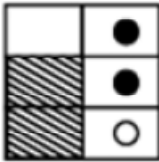
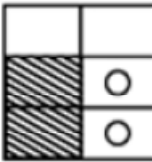



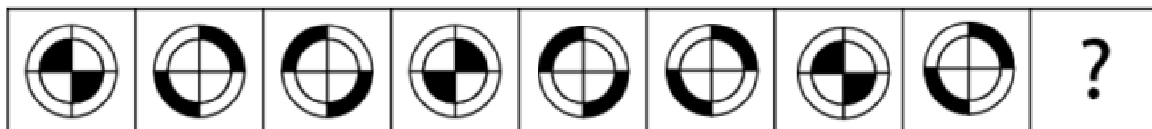

- A.  B.  C.  D.  E. 

www.riolearning.com

22.

¿Cuál es la figura que falta?



- A.  B.  C.  D.  E. 

23.

¿Cuál es la figura que falta?

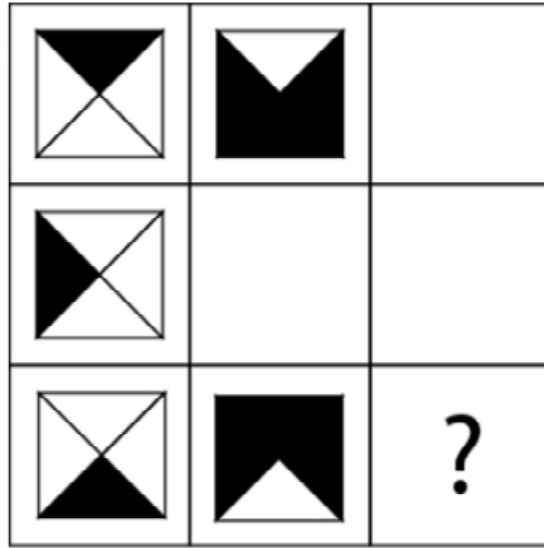

- A.
- B.
- C.
- D.
- E.

24.

¿Cuál es la figura que falta?

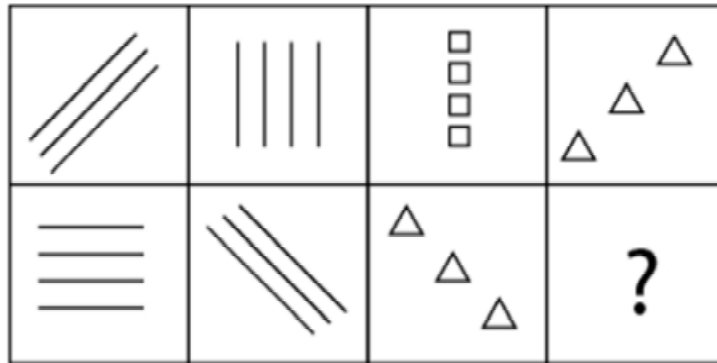

A.



B.



C.



D.









E.

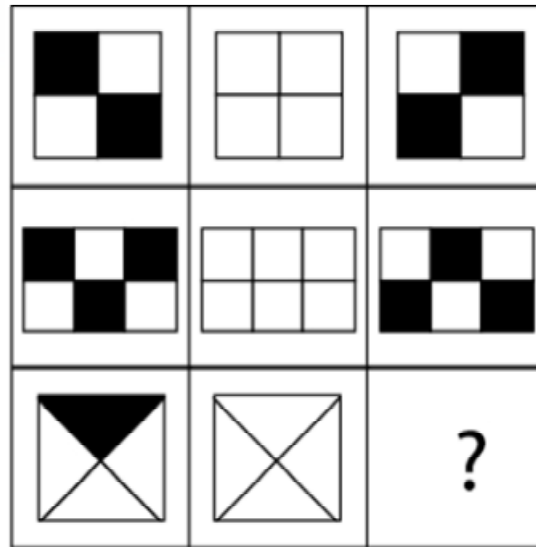

25.

¿Cuál es la figura que falta?





- A.  B.  C.  D.  E. 

26.

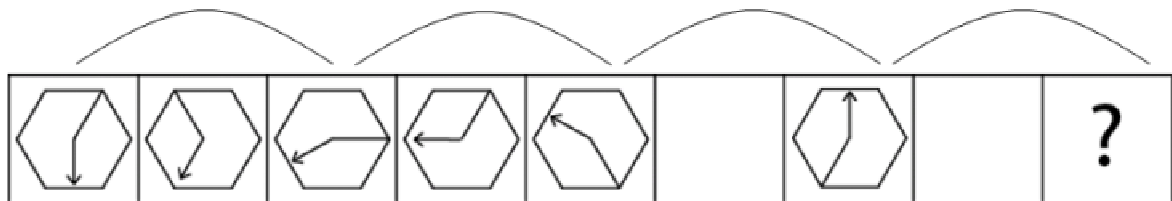
¿Cuál es la figura que falta?

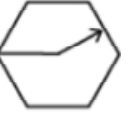

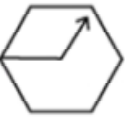
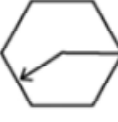



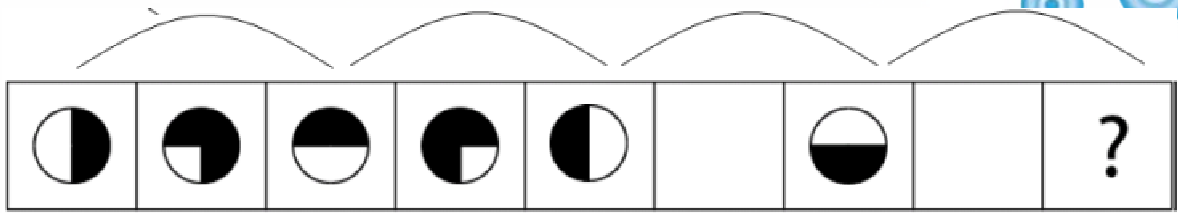

- A.  B.  C.  D.  E. 

www.riolearning.com

27.

¿Cuál es la figura que falta?



- A.  B.  C.  D.  E. 

www.riolearning.com

28.

¿Cuál es la figura que falta?

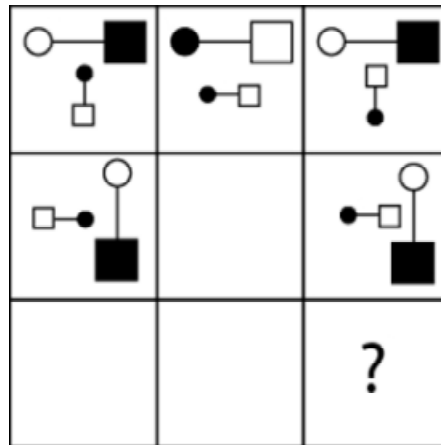

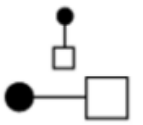
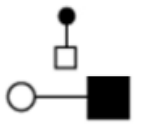
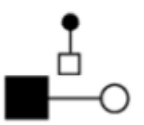
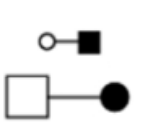
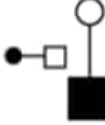
- A.  B.  C.  D.  E. 

29.

¿Cuál es la figura que falta?

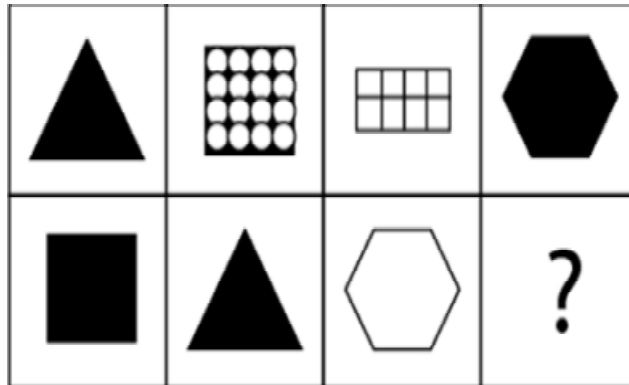

A.



B.



C.



D.



E.



30.

¿Cuál es la figura que falta?

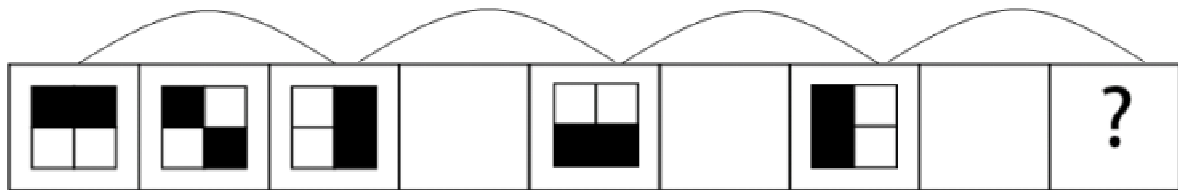

A.



B.



C.

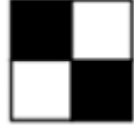

D.



E.





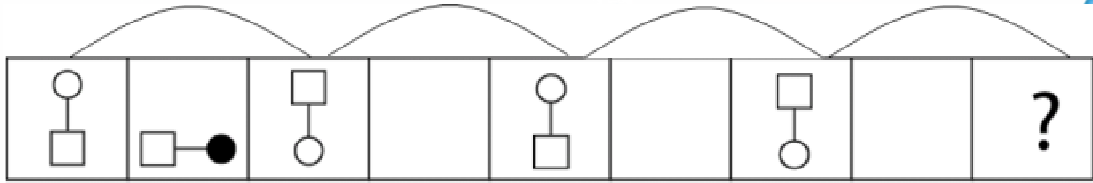

www.riolearning.com

31.

¿Cuál es la figura que falta?







- A.  B.  C.  D.  E. 

www.riolearning.com

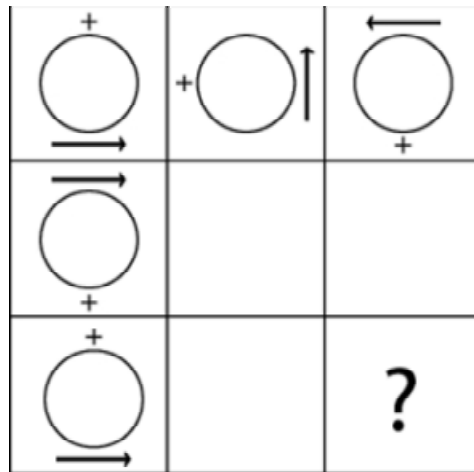
32.

¿Cuál es la figura que falta?

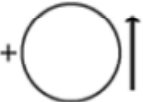





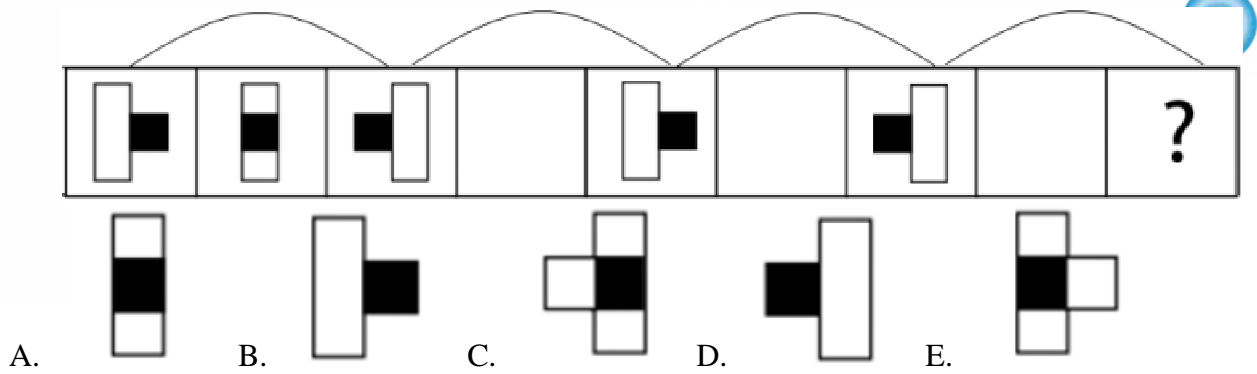

- A.  B.  C.  D.  E. 

www.riolearning.com

33.

¿Cuál es la figura que falta?







A.  B.  C.  D.  E. 

www.riolearning.com

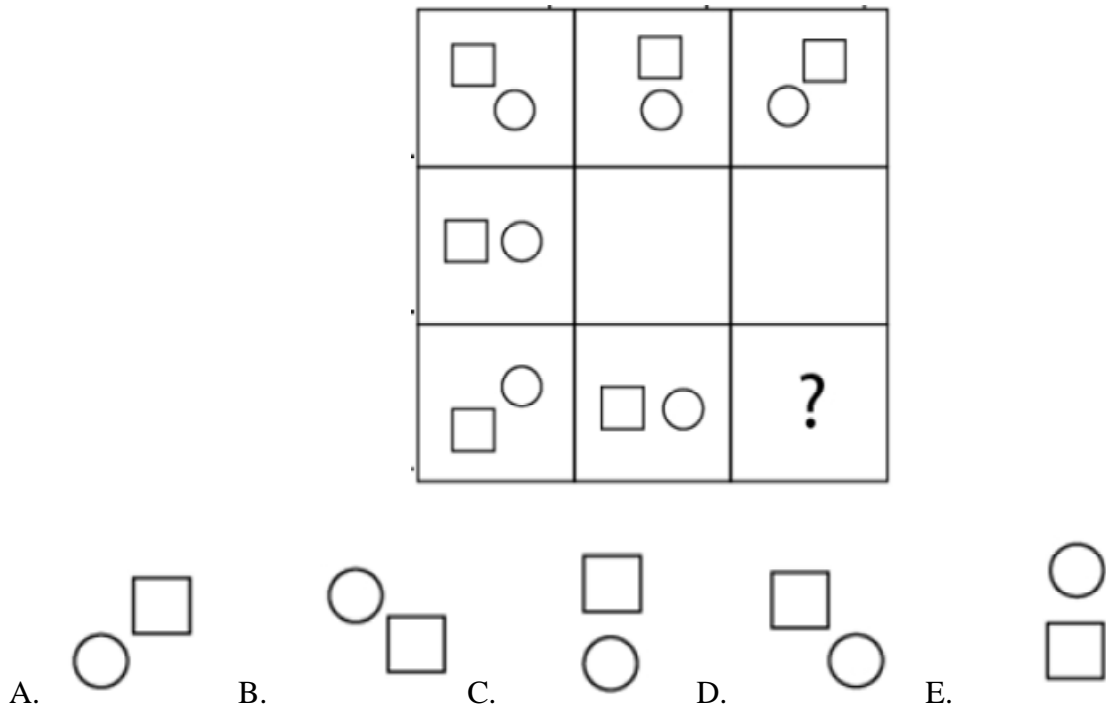
34.

¿Cuál es la figura que falta?

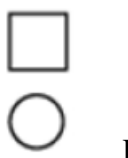

A.  B.  C.  D.  E. 

35.

¿Cuál es la figura que falta?

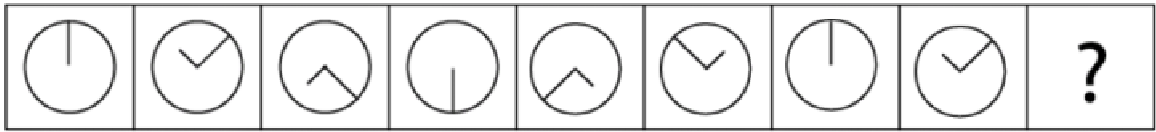

36.

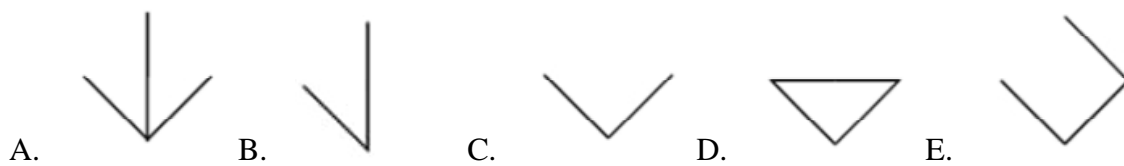
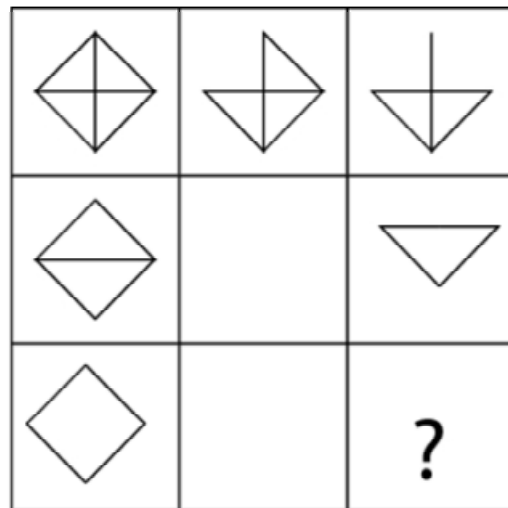

¿Cuál es la figura que falta?



37.

¿Cuál es la figura que falta?



- A.  B.  C.  D.  E. 

38.

¿Cuál es la figura que falta?

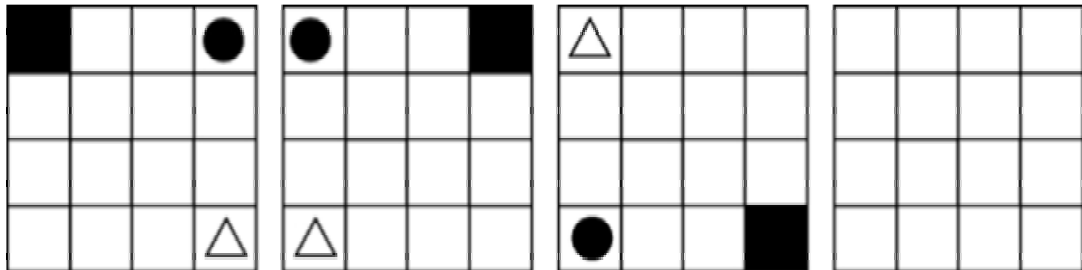

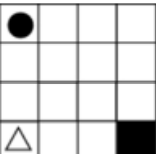
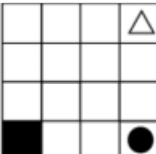
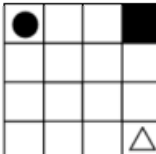
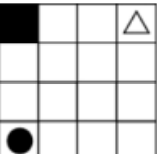
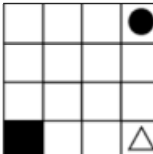
- A.  B.  C.  D.  E. 

www.riolearning.com

39.

¿Cuál es la figura que falta?

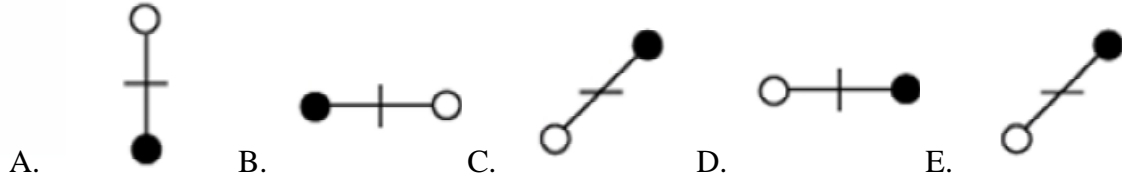
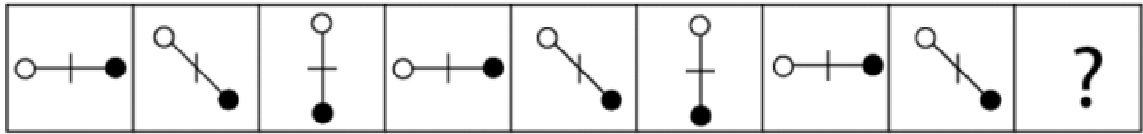

www.riolearning.com

40.

¿Cuál es la figura que falta?

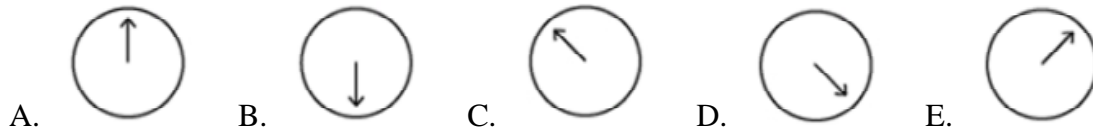
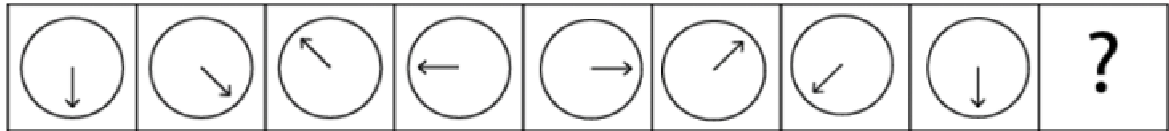

www.riolearning.com

41.

¿Cuál es la figura que falta?

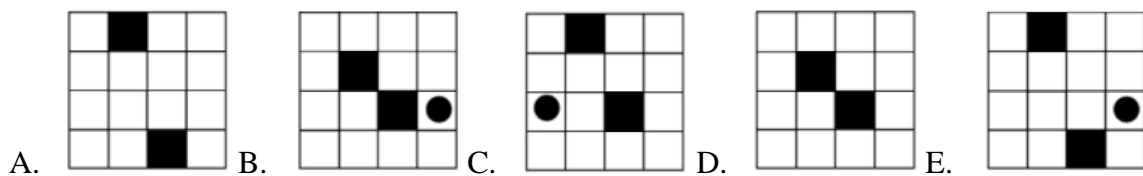
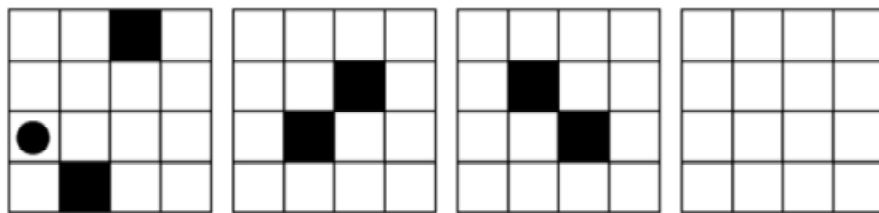



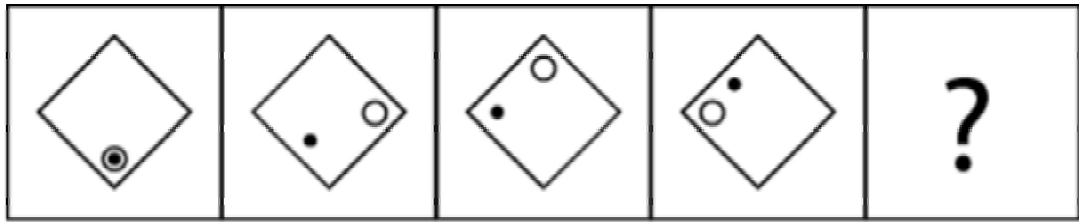

www.riolearning.com

42.

¿Cuál es la figura que falta?

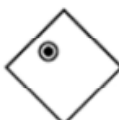

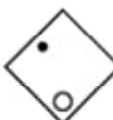



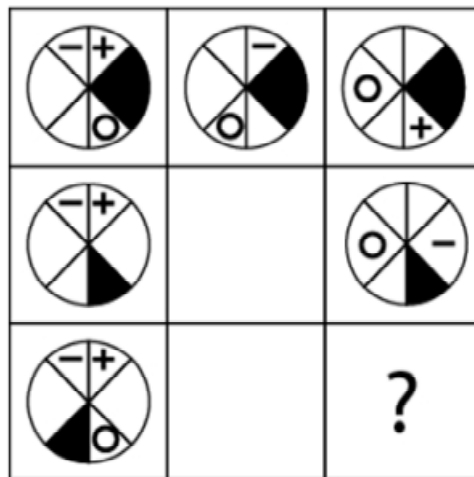

- A.  B.  C.  D.  E. 

www.riolearning.com

43.

¿Cuál es la figura que falta?



- A.  B.  C.  D.  E. 

www.riolearning.com

44.

¿Cuál es la figura que falta?

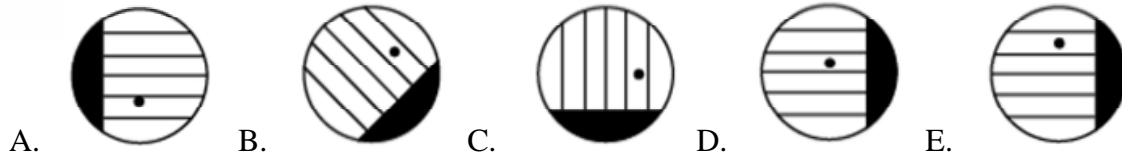
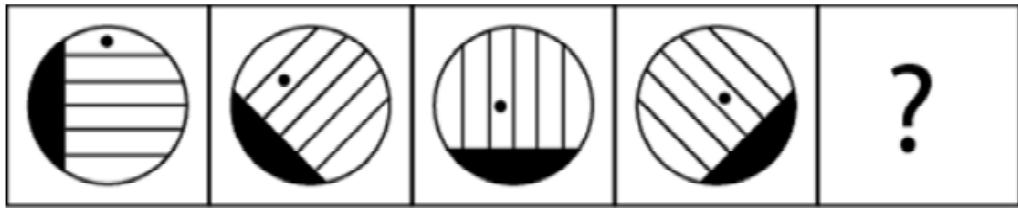

www.riolearning.com

45.

¿Cuál es la figura que falta?

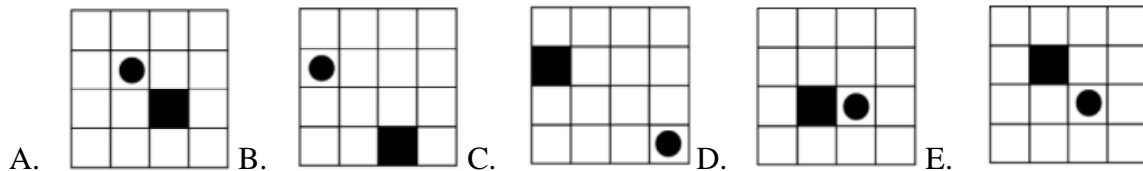
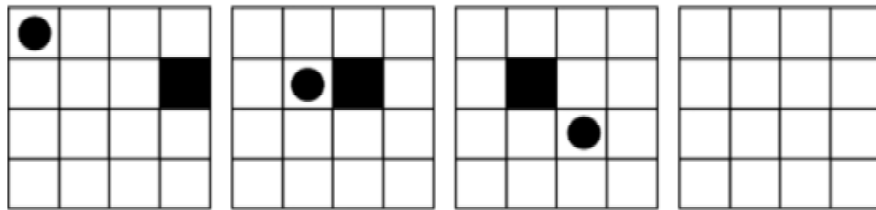

www.riolearning.com

46.

¿Cuál es la figura que falta?

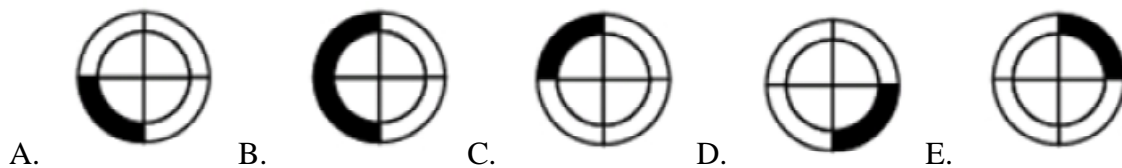
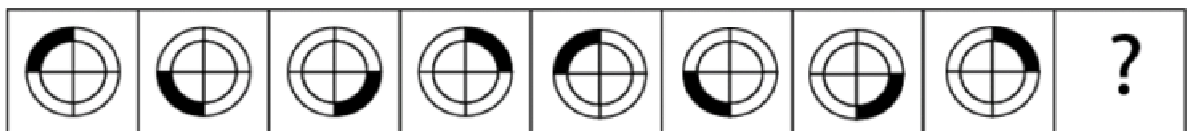



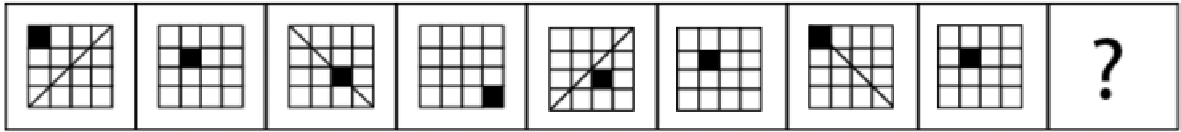

www.riolearning.com

47.

¿Cuál es la figura que falta?

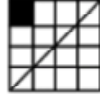
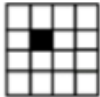





- A.  B.  C.  D.  E. 

www.riolearning.com

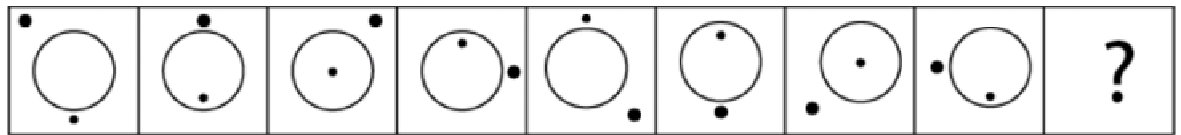
48.

¿Cuál es la figura que falta?







- A.  B.  C.  D.  E. 

www.riolearning.com

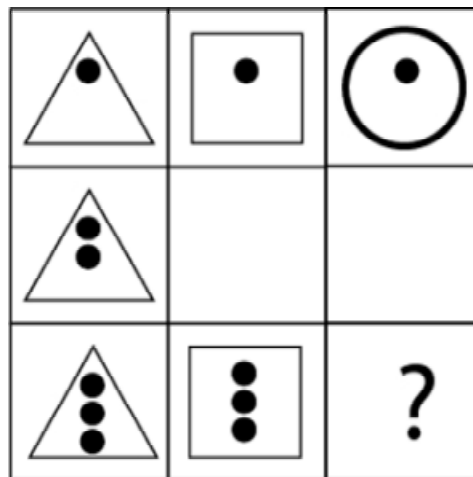
49.

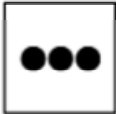
¿Cuál es la figura que falta?



- A.  B.  C.  D.  E. 

www.riolearning.com

50.

¿Cuál es la figura que falta?

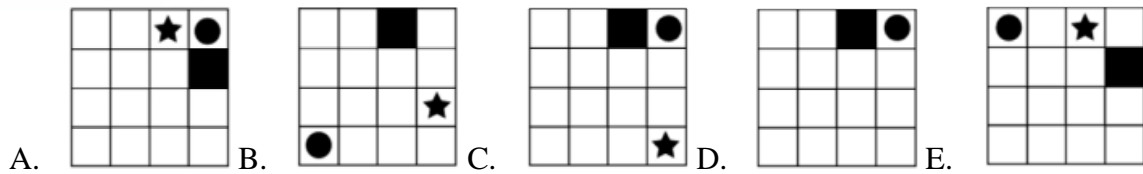
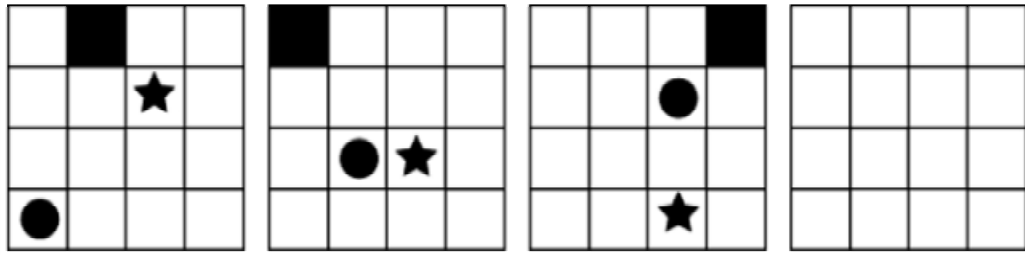

www.riolearning.com

51.

¿Cuál es la figura que falta?

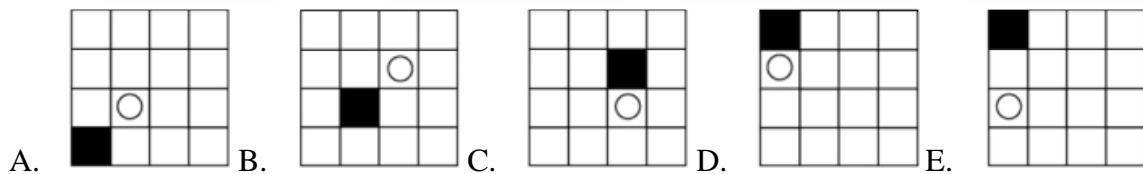
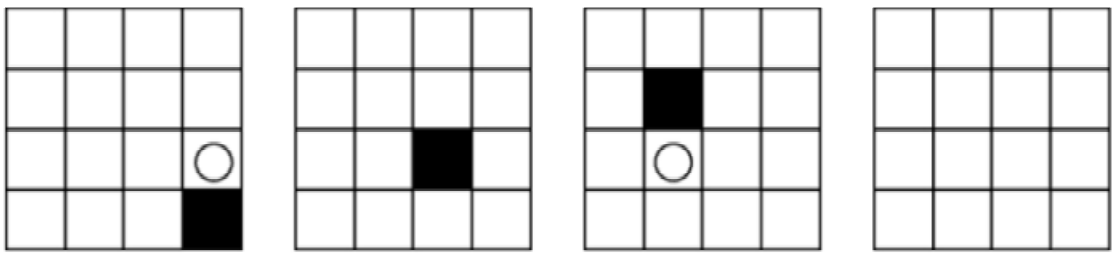

www.riolearning.com

52.

¿Cuál es la figura que falta?

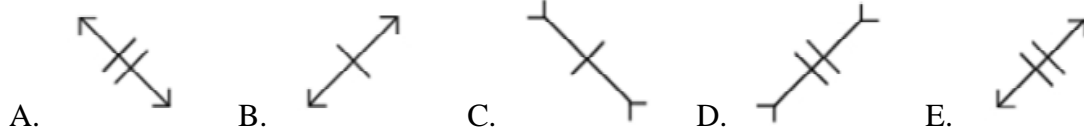
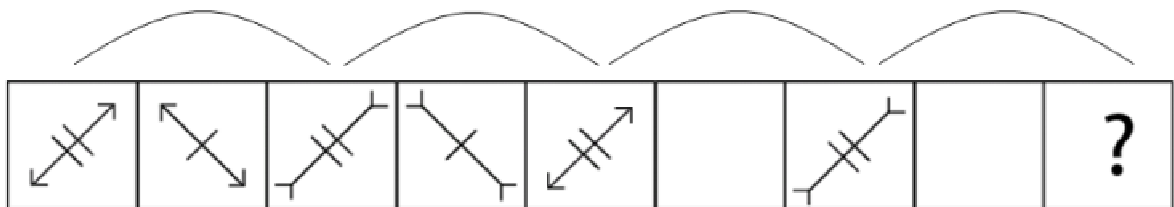

www.riolearning.com

53.

¿Cuál es la figura que falta?

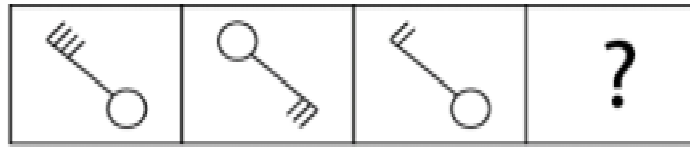

- A.
- B.
- C.
- D.
- E.

www.riolearning.com

54.

¿Cuál es la figura que falta?

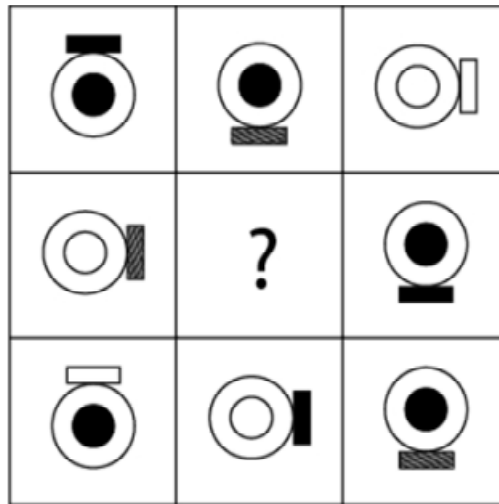



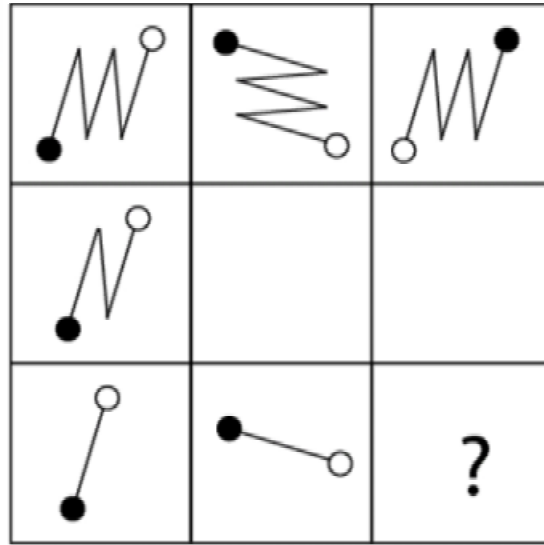

- A.
- B.
- C.
- D.
- E.

55.

¿Cuál es la figura que falta?



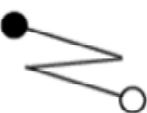

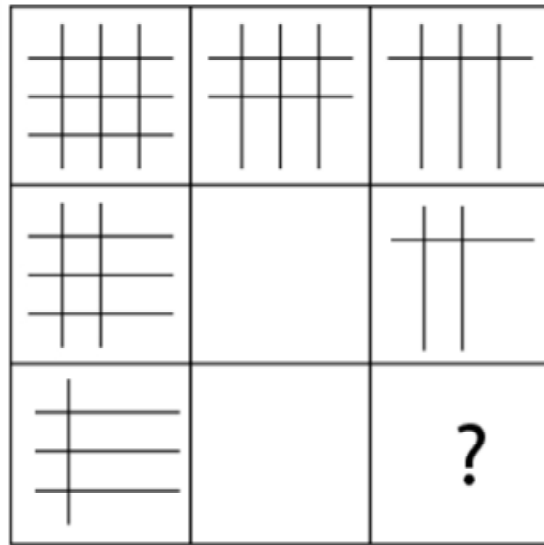

- A.  B.  C.  D.  E. 

56.

¿Cuál es la figura que falta?





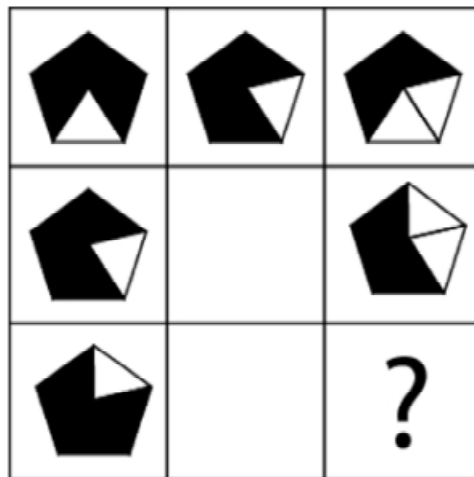

- A.  B.  C.  D.  E. 

57.

¿Cuál es la figura que falta?





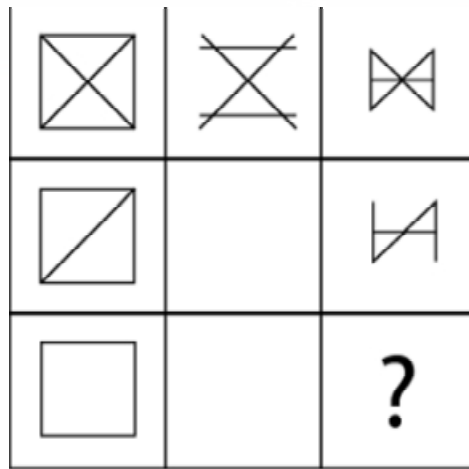

- A.  B.  C.  D.  E. 

58.

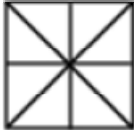
¿Cuál es la figura que falta?





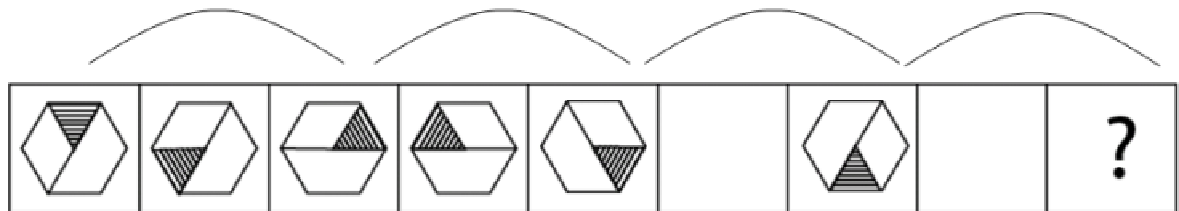

- A.  B.  C.  D.  E. 

59.

¿Cuál es la figura que falta?



- A.  B.  C.  D.  E. 

60.

¿Cuál es la figura que falta?

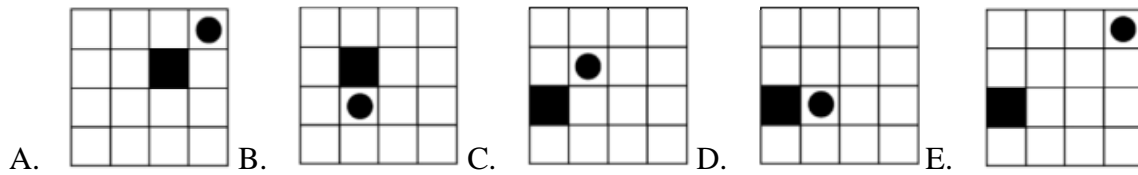
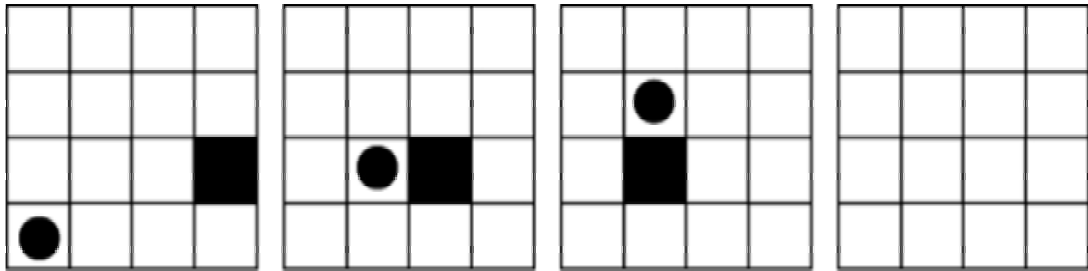

61.

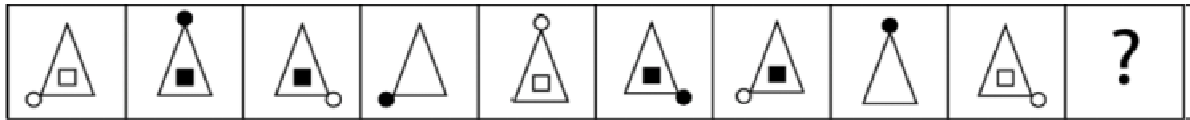

¿Cuál es la figura que falta?

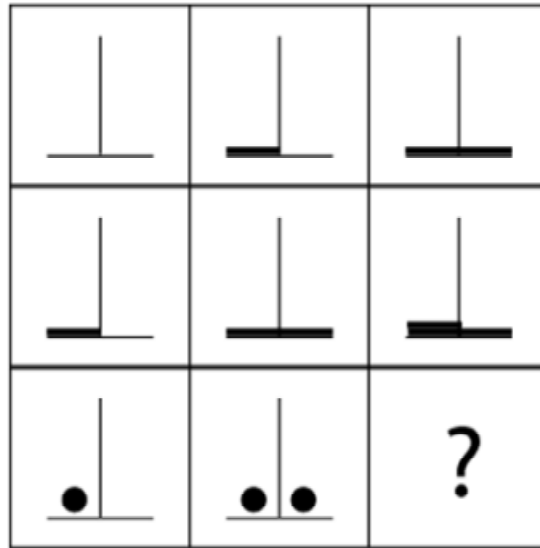

62.

¿Cuál es la figura que falta?

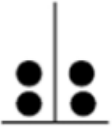

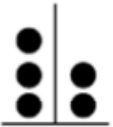
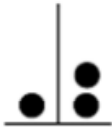
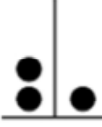
- A.  B.  C.  D.  E. 

63.

¿Cuál es la figura que falta?

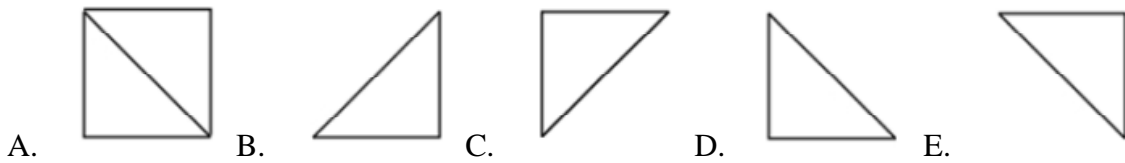
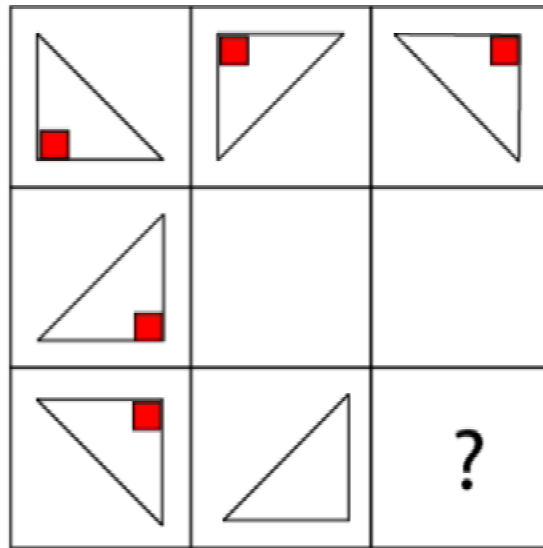

64.

¿Cuál es la figura que falta?

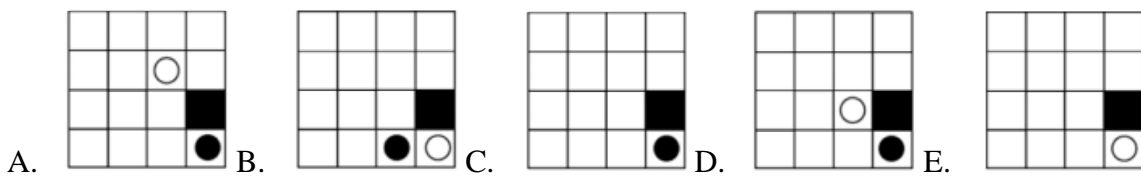
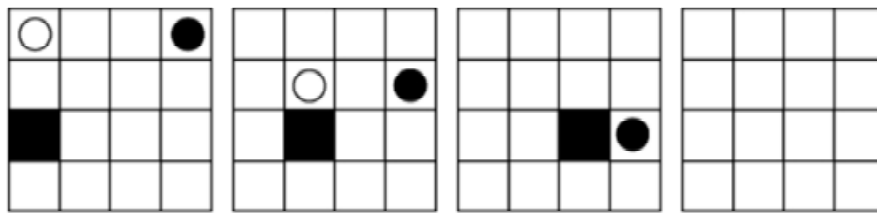

65.

¿Cuál es la figura que falta?

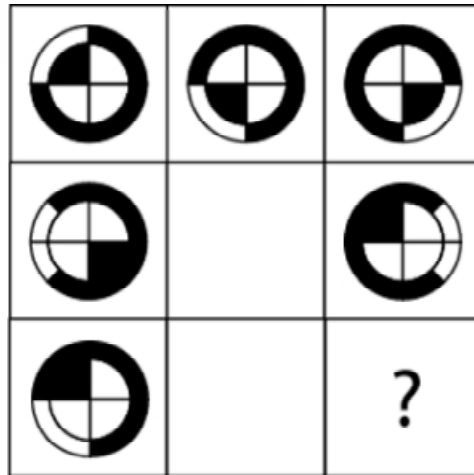

- A.  B.  C.  D.  E. 

66.

¿Cuál es la figura que falta?

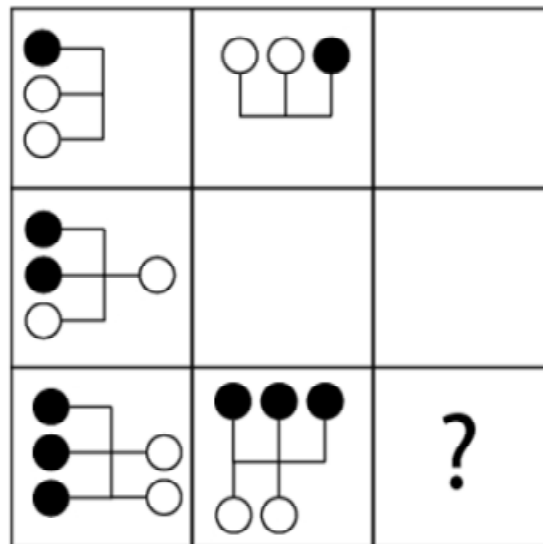

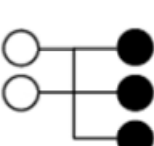
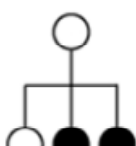
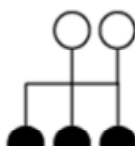
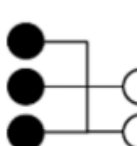
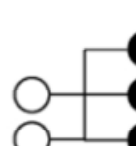

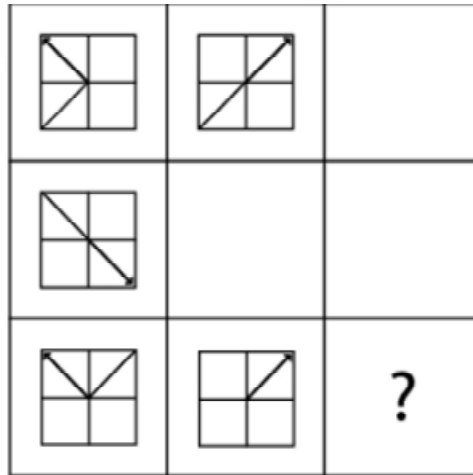

- A.  B.  C.  D.  E. 

67.

¿Cuál es la figura que falta?





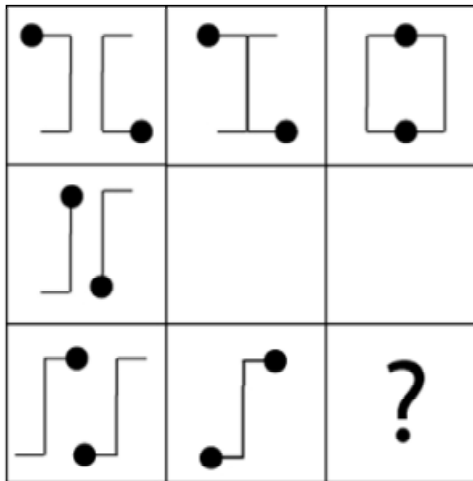

- A.  B.  C.  D.  E. 

68.

¿Cuál es la figura que falta?

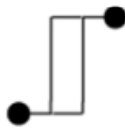





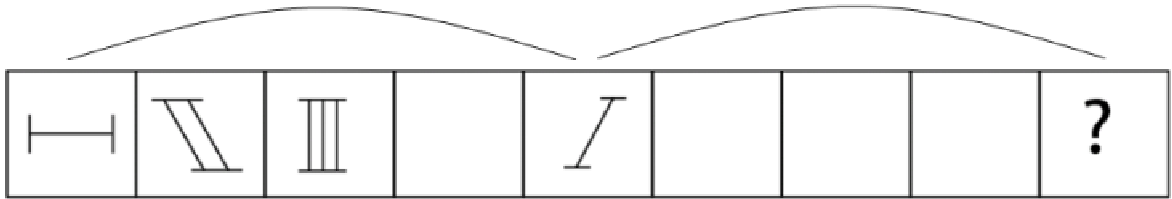

- A.  B.  C.  D.  E. 

www.riolearning.com

69.

¿Cuál es la figura que falta?







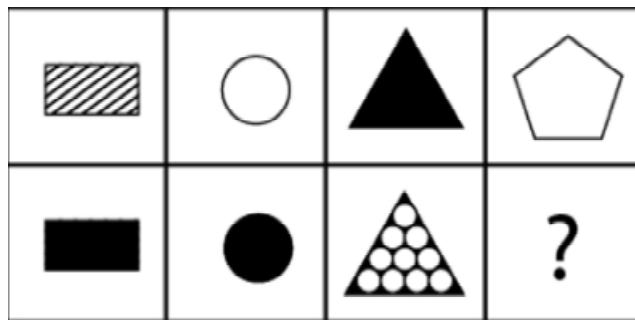

- A.  B.  C.  D.  E. 

www.riolearning.com

70.

¿Cuál es la figura que falta?







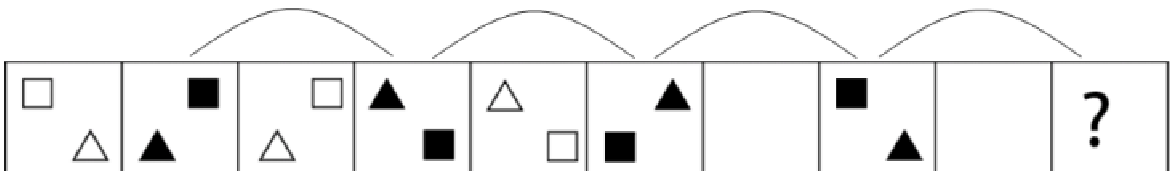

- A.  B.  C.  D.  E. 

www.riolearning.com

71.

¿Cuál es la figura que falta?



- A.  B.  C.  D.  E. 

www.riolearning.com

72.

¿Cuál es la figura que falta?

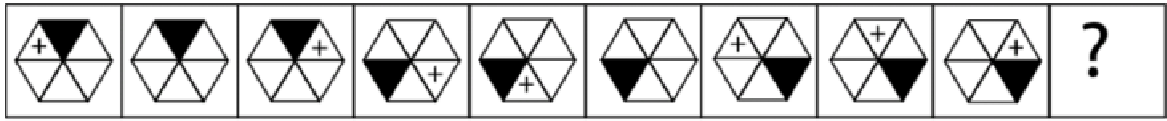





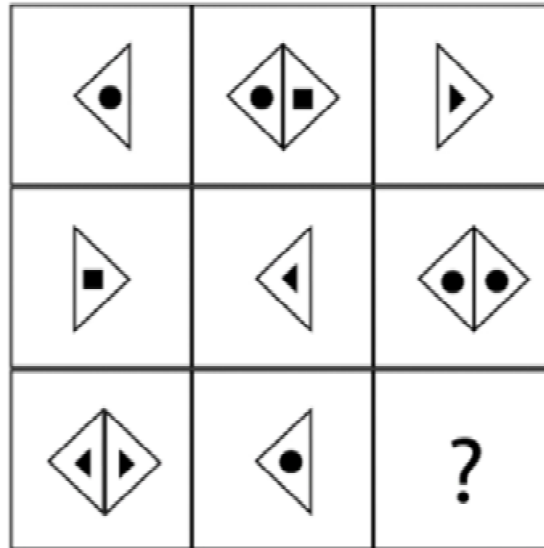

- A.  B.  C.  D.  E. 

www.riolearning.com

73.

¿Cuál es la figura que falta?



- A.  B.  C.  D.  E. 

74.

¿Cuál es la figura que falta?

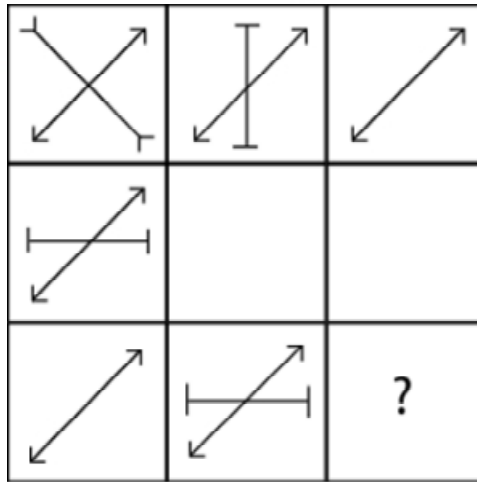

- A.
- B.
- C.
- D.
- E.

75.

¿Cuál es la figura que falta?

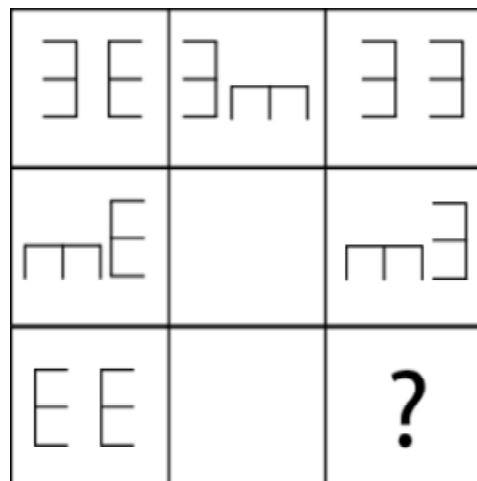

- A.
- B.
- C.
- D.
- E.

www.riolearning.com

76.

¿Cuál es la figura que falta?

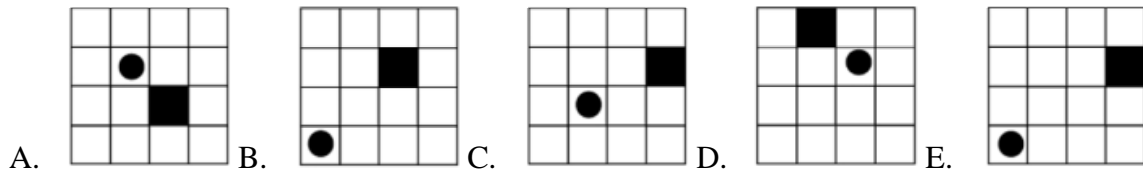
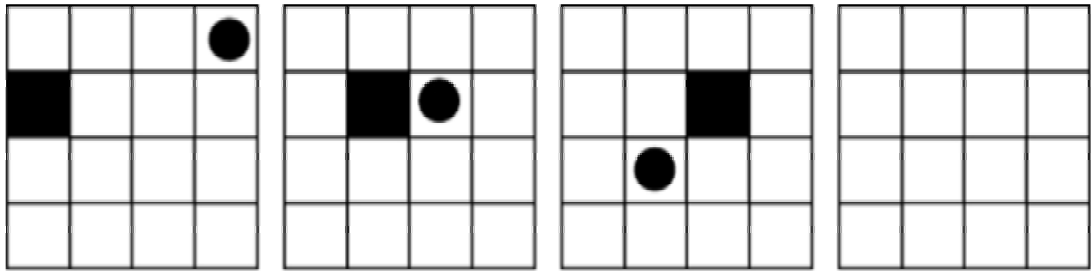

77.

¿Cuál es la figura que falta?

www.riolearning.com

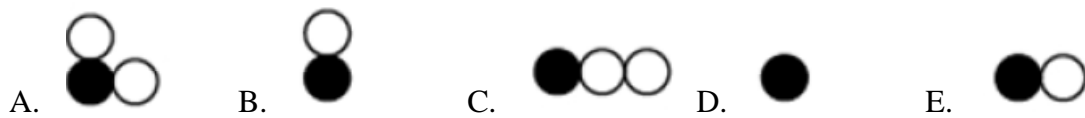
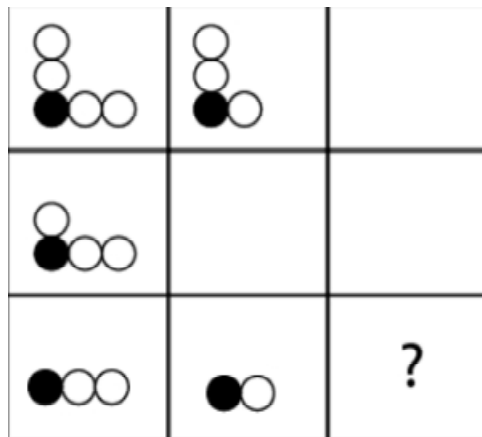

78.

¿Cuál es la figura que falta?

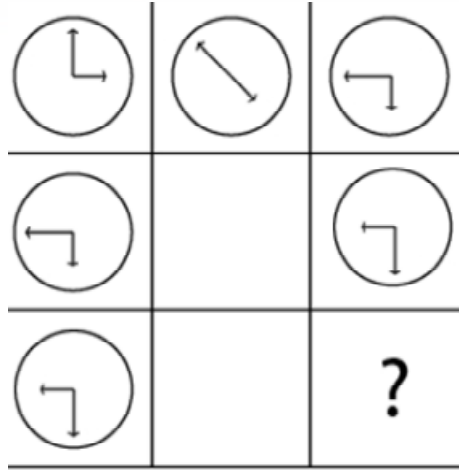

- A.
- B.
- C.
- D.
- E.

79.

¿Cuál es la figura que falta?

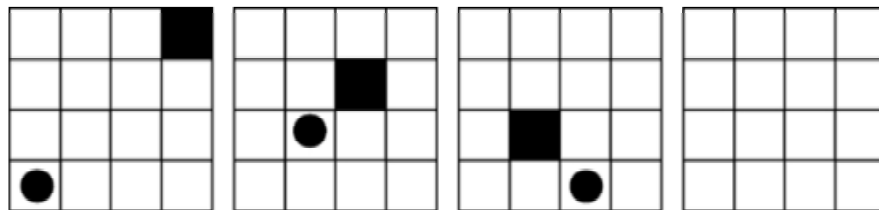





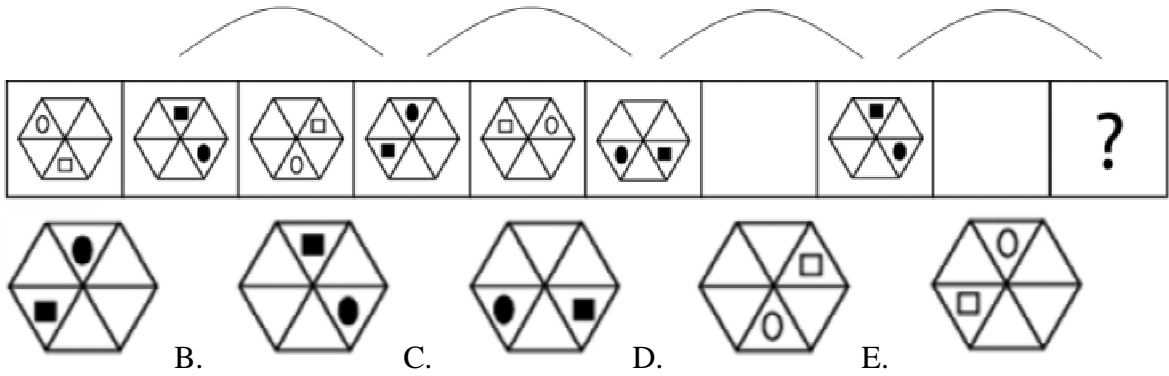

- A.
- B.
- C.
- D.
- E.

www.riolearning.com

80.

¿Cuál es la figura que falta?





A.  B.  C.  D.  E. 

www.riolearning.com

81.

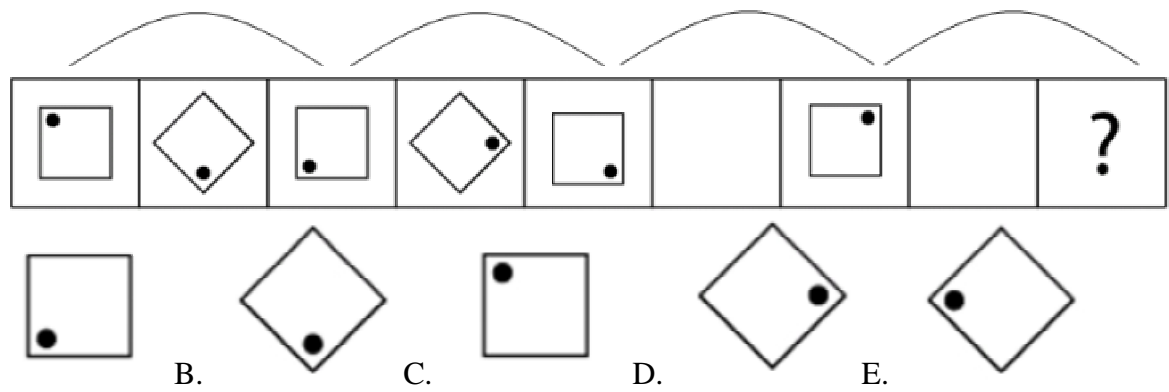
¿Cuál es la figura que falta?



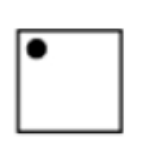
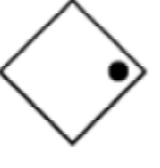
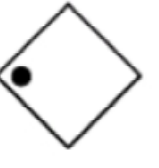

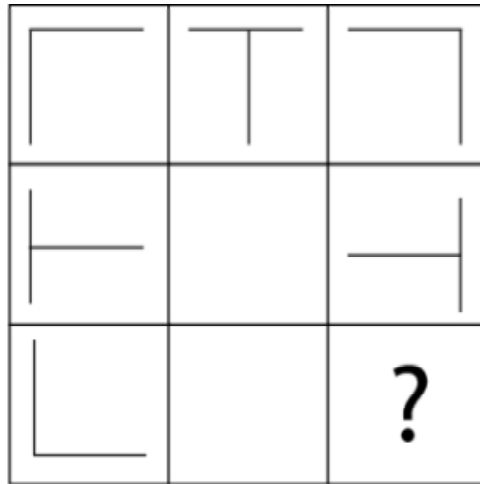

A.  B.  C.  D.  E. 

82.

¿Cuál es la figura que falta?





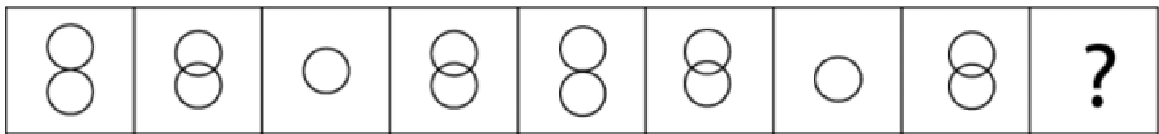

- A.  B.  C.  D.  E. 

83.

¿Cuál es la figura que falta?





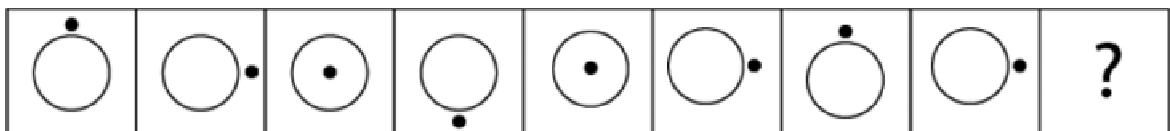

- A.  B.  C.  D.  E. 

84.

¿Cuál es la figura que falta?

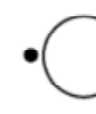

- A.  B.  C.  D.  E. 

www.riolearning.com

85.

¿Cuál es la figura que falta?

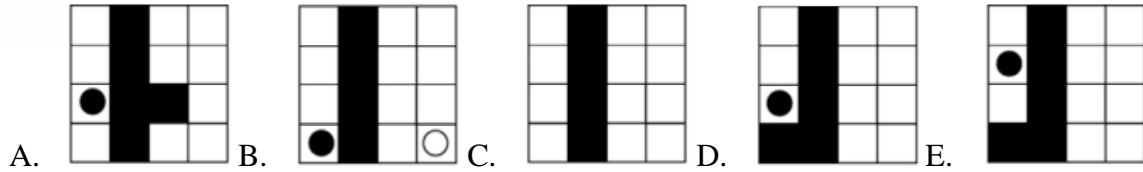
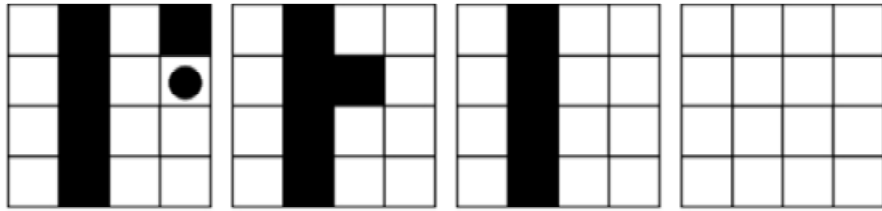

www.riolearning.com

86.

¿Cuál es la figura que falta?

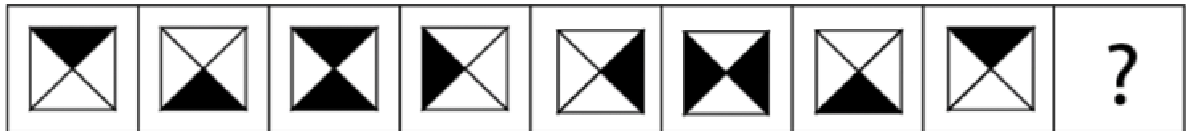

87.

¿Cuál es la figura que falta?

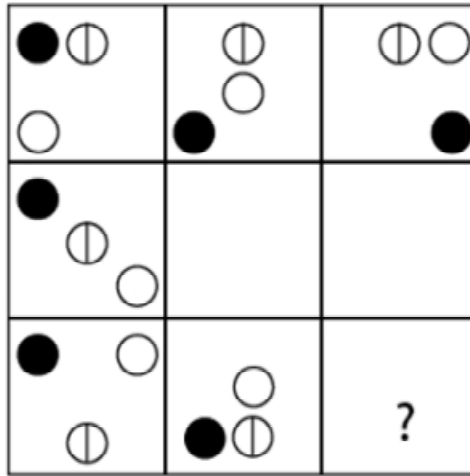

- A.  B.  C.  D.  E. 

88.

¿Cuál es la figura que falta?

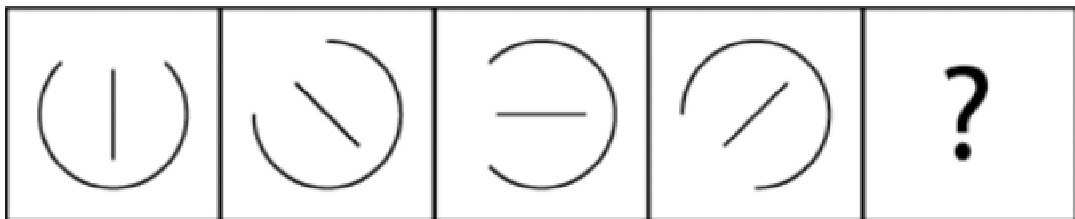

- A.  B.  C.  D.  E. 

www.riolearning.com

89.

¿Cuál es la figura que falta?

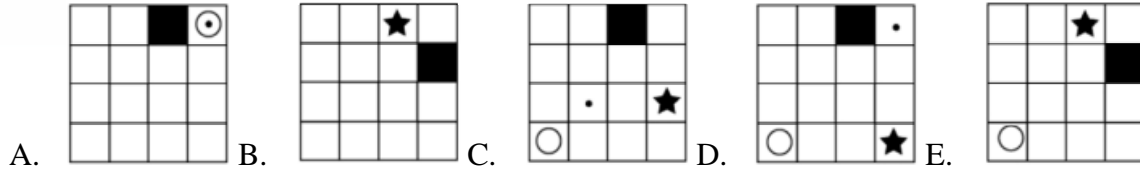
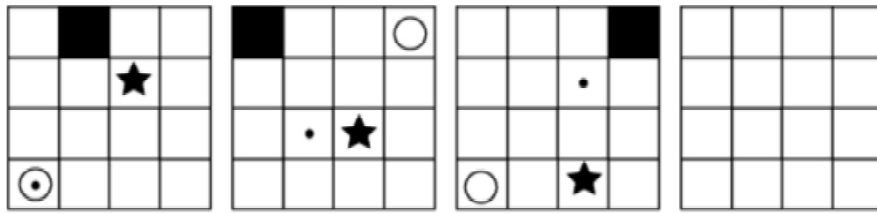

90.

¿Cuál es la figura que falta?



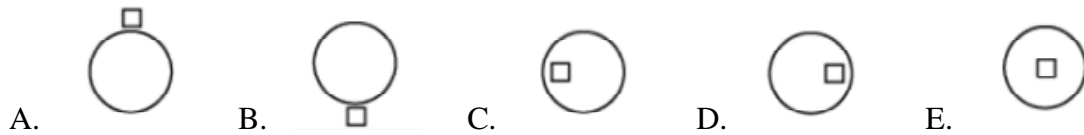
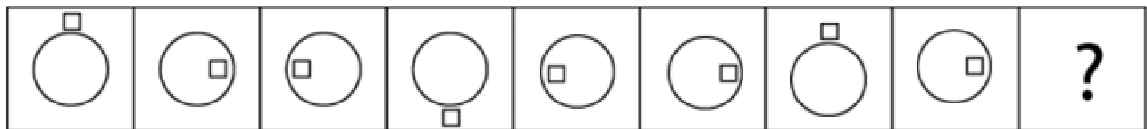

www.riolearning.com

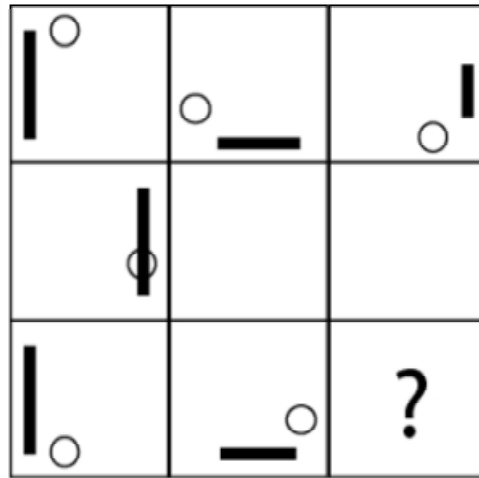

91.

¿Cuál es la figura que falta?





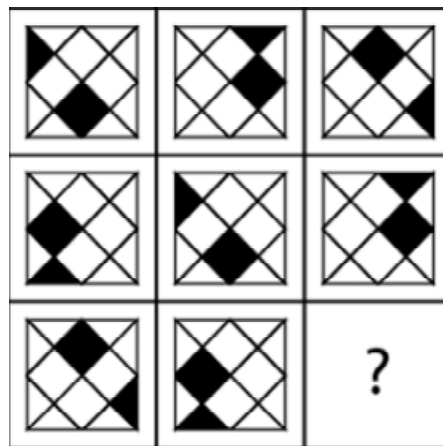

- A.  B.  C.  D.  E. 

92.

¿Cuál es la figura que falta?



- A.  B.  C.  D.  E. 

www.riolearning.com

93.

¿Cuál es la figura que falta?

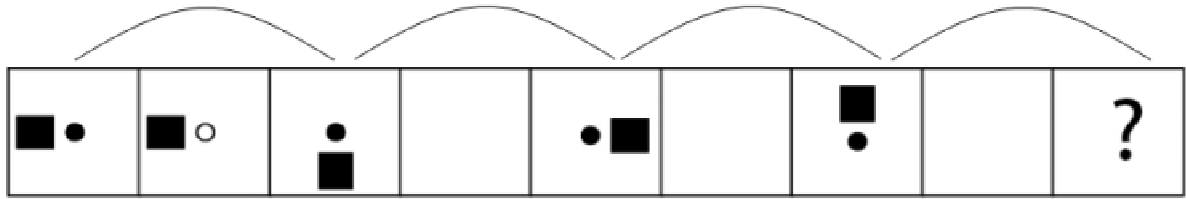

A.

B.

C.

D.

E.

www.riolearning.com

94.

¿Cuál es la figura que falta?

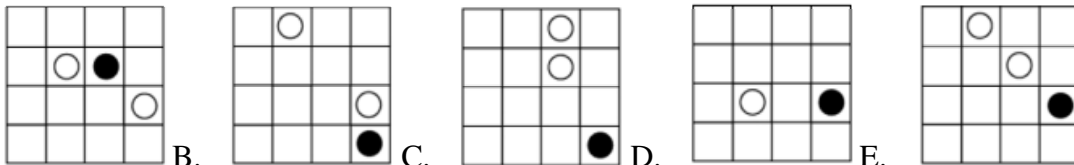
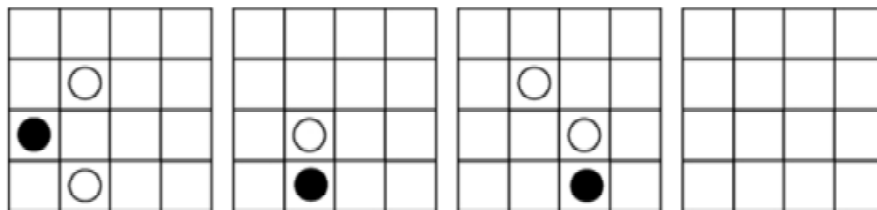

A.

B.

C.

D.

E.

95.

¿Cuál es la figura que falta?

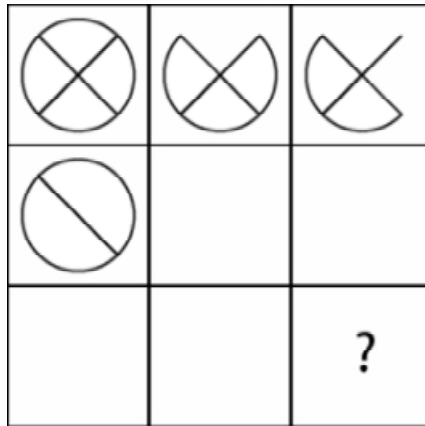

- A.
- B.
- C.
- D.
- E.

96.

¿Cuál es la figura que falta?

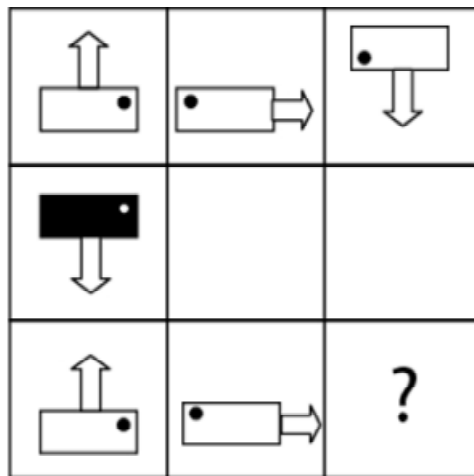

- A.
- B.
- C.
- D.
- E.

97.

¿Cuál es la figura que falta?

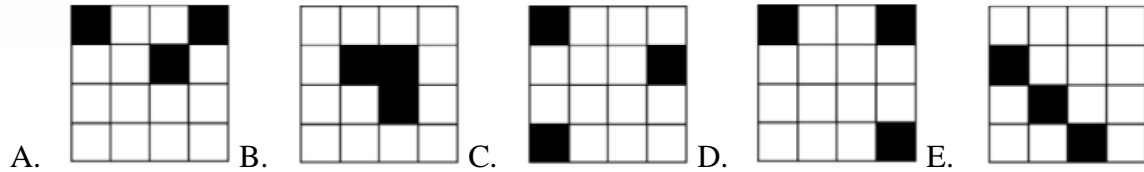
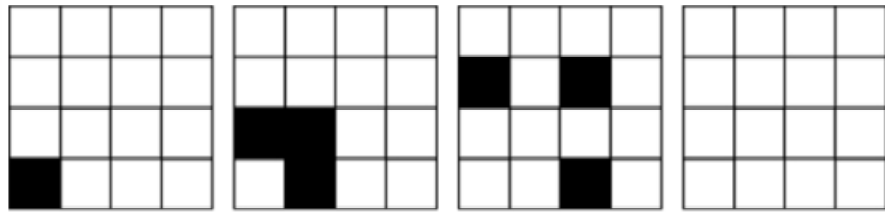

98.



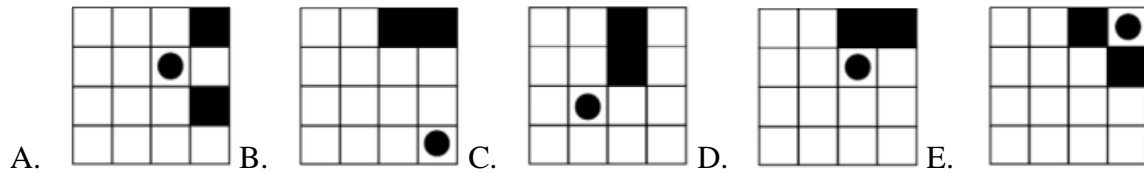
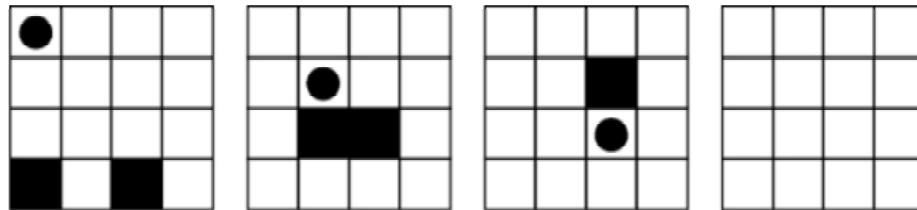

¿Cuál es la figura que falta?

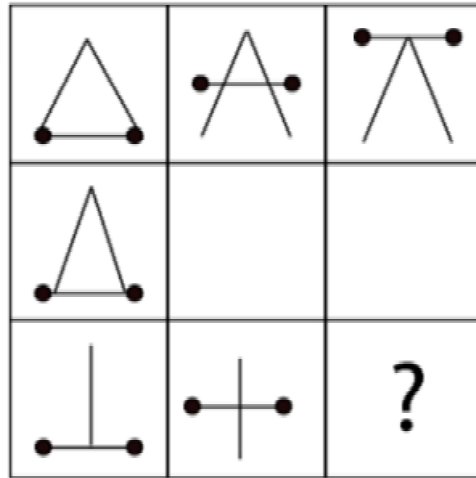

99.

¿Cuál es la figura que falta?





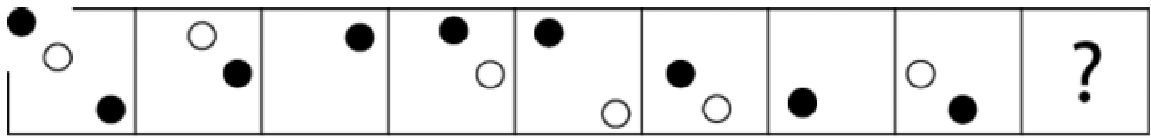

- A.  B.  C.  D.  E. 

100.

¿Cuál es la figura que falta?



- A.  B.  C.  D.  E. 

ACCESO A LA EDUCACIÓN SUPERIOR TAE100_001

Answer Section

MULTIPLE CHOICE



1. ANS: D PTS: 1
2. ANS: A PTS: 1
3. ANS: C PTS: 1
4. ANS: B PTS: 1
5. ANS: B PTS: 1
6. ANS: E PTS: 1
7. ANS: A PTS: 1
8. ANS: E PTS: 1
9. ANS: E PTS: 1
10. ANS: E PTS: 1
11. ANS: E PTS: 1
12. ANS: A PTS: 1
13. ANS: A PTS: 1
14. ANS: A PTS: 1
15. ANS: A PTS: 1
16. ANS: E PTS: 1
17. ANS: B PTS: 1
18. ANS: B PTS: 1
19. ANS: D PTS: 1
20. ANS: C PTS: 1
21. ANS: A PTS: 1
22. ANS: C PTS: 1
23. ANS: E PTS: 1
24. ANS: D PTS: 1
25. ANS: D PTS: 1
26. ANS: A PTS: 1
27. ANS: E PTS: 1
28. ANS: C PTS: 1
29. ANS: D PTS: 1
30. ANS: E PTS: 1
31. ANS: A PTS: 1
32. ANS: E PTS: 1
33. ANS: B PTS: 1
34. ANS: D PTS: 1
35. ANS: A PTS: 1
36. ANS: C PTS: 1
37. ANS: E PTS: 1
38. ANS: B PTS: 1
39. ANS: A PTS: 1
40. ANS: A PTS: 1

| | | |
|-----|--------|--------|
| 41. | ANS: E | PTS: 1 |
| 42. | ANS: A | PTS: 1 |
| 43. | ANS: C | PTS: 1 |
| 44. | ANS: E | PTS: 1 |
| 45. | ANS: C | PTS: 1 |
| 46. | ANS: C | PTS: 1 |
| 47. | ANS: E | PTS: 1 |
| 48. | ANS: B | PTS: 1 |
| 49. | ANS: B | PTS: 1 |
| 50. | ANS: D | PTS: 1 |
| 51. | ANS: E | PTS: 1 |
| 52. | ANS: E | PTS: 1 |
| 53. | ANS: D | PTS: 1 |
| 54. | ANS: B | PTS: 1 |
| 55. | ANS: D | PTS: 1 |
| 56. | ANS: D | PTS: 1 |
| 57. | ANS: A | PTS: 1 |
| 58. | ANS: E | PTS: 1 |
| 59. | ANS: A | PTS: 1 |
| 60. | ANS: E | PTS: 1 |
| 61. | ANS: C | PTS: 1 |
| 62. | ANS: E | PTS: 1 |
| 63. | ANS: D | PTS: 1 |
| 64. | ANS: C | PTS: 1 |
| 65. | ANS: E | PTS: 1 |
| 66. | ANS: A | PTS: 1 |
| 67. | ANS: A | PTS: 1 |
| 68. | ANS: D | PTS: 1 |
| 69. | ANS: C | PTS: 1 |
| 70. | ANS: C | PTS: 1 |
| 71. | ANS: B | PTS: 1 |
| 72. | ANS: D | PTS: 1 |
| 73. | ANS: D | PTS: 1 |
| 74. | ANS: C | PTS: 1 |
| 75. | ANS: A | PTS: 1 |
| 76. | ANS: E | PTS: 1 |
| 77. | ANS: D | PTS: 1 |
| 78. | ANS: E | PTS: 1 |
| 79. | ANS: D | PTS: 1 |
| 80. | ANS: A | PTS: 1 |
| 81. | ANS: C | PTS: 1 |
| 82. | ANS: E | PTS: 1 |
| 83. | ANS: C | PTS: 1 |
| 84. | ANS: A | PTS: 1 |
| 85. | ANS: E | PTS: 1 |

| | | |
|------|--------|--------|
| 86. | ANS: A | PTS: 1 |
| 87. | ANS: C | PTS: 1 |
| 88. | ANS: C | PTS: 1 |
| 89. | ANS: A | PTS: 1 |
| 90. | ANS: C | PTS: 1 |
| 91. | ANS: E | PTS: 1 |
| 92. | ANS: D | PTS: 1 |
| 93. | ANS: E | PTS: 1 |
| 94. | ANS: E | PTS: 1 |
| 95. | ANS: C | PTS: 1 |
| 96. | ANS: A | PTS: 1 |
| 97. | ANS: D | PTS: 1 |
| 98. | ANS: B | PTS: 1 |
| 99. | ANS: B | PTS: 1 |
| 100. | ANS: D | PTS: 1 |



Anexo

TAE20_001_001 ID:A

Modelo de Examen de Acceso a la Educación Superior TAE20_001_001 ID: A

www.riolcarning.com

¿qué falta?

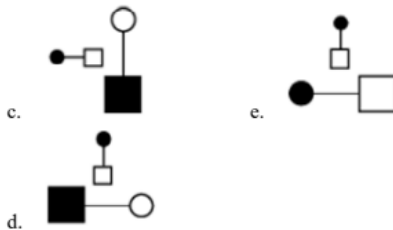
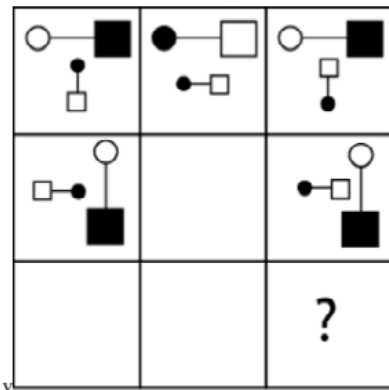

En la parte superior derecha del documento se muestra un código que indica el tipo de examen, número de preguntas y el ID del TEST (se cuenta con cuatro A, B, C, D)

Esta información te permitirá buscar el solucionario.

El solucionario lo puedes encontrar en nuestras redes sociales o en la página www.multimevi.com en la sección DESCARGAS

Aula virtual

www.riolearning.com



Ejercicios Acceso a la Educación Superior tiene licencia [CC BY-NC 4.0](https://creativecommons.org/licenses/by-nc/4.0/) © 2 por EdFr@MeVi



Forma

Test Version

| | | | | | | | | | | |
|--|--|--|--|--|--|--|--|--|--|--|
| | | | | | | | | | | |
|--|--|--|--|--|--|--|--|--|--|--|

Nombre: _____

Asignatura: _____

Fecha: _____

A

B

C

D

0 0 0 0 0 0 0 0 0

1 1 1 1 1 1 1 1 1

2 2 2 2 2 2 2 2 2

3 3 3 3 3 3 3 3 3

4 4 4 4 4 4 4 4 4

5 5 5 5 5 5 5 5 5

6 6 6 6 6 6 6 6 6

7 7 7 7 7 7 7 7 7

8 8 8 8 8 8 8 8 8

9 9 9 9 9 9 9 9 9

Cédula - Código

Ejemplo

A B C D E

Calificación

| |
|--|
| |
|--|

- Utilice lápiz para marcar la respuesta.
- Marque un círculo completo
- Borre completamente el círculo para marcar una nueva respuesta

1 A B C D E

2 A B C D E

3 A B C D E

4 A B C D E

5 A B C D E

6 A B C D E

7 A B C D E

8 A B C D E

9 A B C D E

10 A B C D E

11 A B C D E

12 A B C D E

13 A B C D E

14 A B C D E

15 A B C D E

16 A B C D E

17 A B C D E

18 A B C D E

19 A B C D E

20 A B C D E

21 A B C D E

22 A B C D E

23 A B C D E

24 A B C D E

25 A B C D E

26 A B C D E

27 A B C D E

28 A B C D E

29 A B C D E

30 A B C D E

31 A B C D E

32 A B C D E

33 A B C D E

34 A B C D E

35 A B C D E

36 A B C D E

37 A B C D E

38 A B C D E

39 A B C D E

40 A B C D E

41 A B C D E

42 A B C D E

43 A B C D E

44 A B C D E

45 A B C D E

46 A B C D E

47 A B C D E

48 A B C D E

49 A B C D E

50 A B C D E

51 A B C D E

52 A B C D E

53 A B C D E

54 A B C D E

55 A B C D E

56 A B C D E

57 A B C D E

58 A B C D E

59 A B C D E

60 A B C D E

61 A B C D E

62 A B C D E

63 A B C D E

64 A B C D E

65 A B C D E

66 A B C D E

67 A B C D E

68 A B C D E

69 A B C D E

70 A B C D E

71 A B C D E

72 A B C D E

73 A B C D E

74 A B C D E

75 A B C D E

76 A B C D E

77 A B C D E

78 A B C D E

79 A B C D E

80 A B C D E

81 A B C D E

82 A B C D E

83 A B C D E

84 A B C D E

85 A B C D E

86 A B C D E

87 A B C D E

88 A B C D E

89 A B C D E

90 A B C D E

91 A B C D E

92 A B C D E

93 A B C D E

94 A B C D E

95 A B C D E

96 A B C D E

97 A B C D E

98 A B C D E

99 A B C D E

100 A B C D E



| ENLACE | DETALLE | QR |
|---|---|---|
| http://www.multimevi.com/ | Página web MULTIMEVI, donde encontrarás noticias y recursos |  |
| https://t.me/+Klr3YaM42_ZhZTIx | Grupo de apoyo en TELEGRAM |  |
| https://chat.whatsapp.com/IQuCCcZjtLjIkLfgzXo68Y | <u>GRUPO DE WHATSAPP</u> |  |
| https://whatsapp.com/channel/0029VaBB2zQHwXb5Vhn9Yw1W | Canal de noticias WhatsApp |  |
| https://www.facebook.com/multimevi.ec/ | Perfil de facebook |  |
| https://www.facebook.com/groups/multimevi | Grupo FULL Rectivos |  |
| https://www.tiktok.com/@multimevi | Canal de TIK TOK |  |
| https://www.instagram.com/multimevi.ec/ | Canal de Instagram |  |
| https://twitter.com/multimevi | Red X |  |



Modelo X

Plataforma MOODLE

 www.riolearning.com

Página Web



www.multimevi.com

Redes Sociales



Procesos



ACCESO a la Educación Superior
SENESCYT

QUIERO SER MAESTRO
Ministerio de Educación