



Ejercicios



Razonamiento Abstracto

Preguntas modelo
examen de acceso a la educación superior



ACCESO a la Educación Superior
SENESCYT

QUIERO SER MAESTRO
Ministerio de Educación

ACCESO A LA EDUCACIÓN SUPERIOR TAE100_001

Opción Múltiple

Elige la opción que complete mejor el enunciado o que responda mejor a la pregunta.

www.riollearning.com

1.

¿Cuál es la figura que falta?

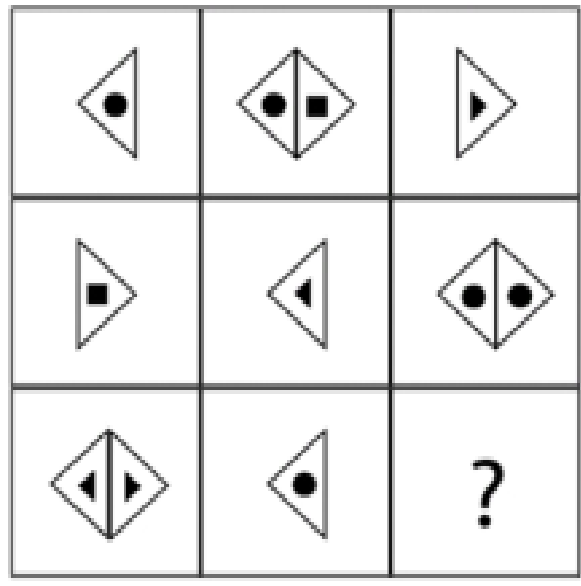

A.

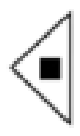

B.



C.

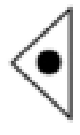

D.

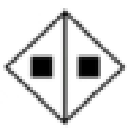

E.

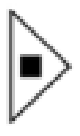

www.riollearning.com

2. ¿Cuál es la figura que falta?

- A.
- B.
- C.
- D.
- E.

www.riollearning.com

3.

¿Cuál es la figura que falta?

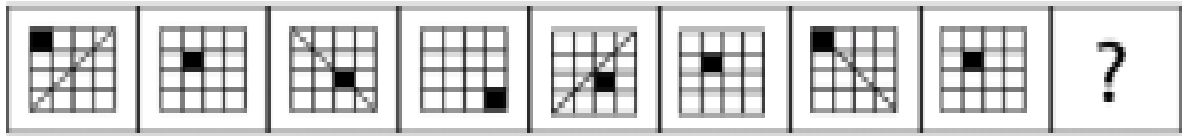

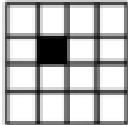
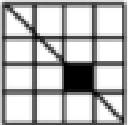
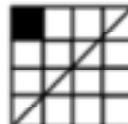
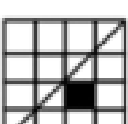
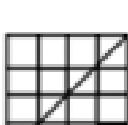
- A. 
- B. 
- C. 
- D. 
- E. 

4.

¿Cuál es la figura que falta?

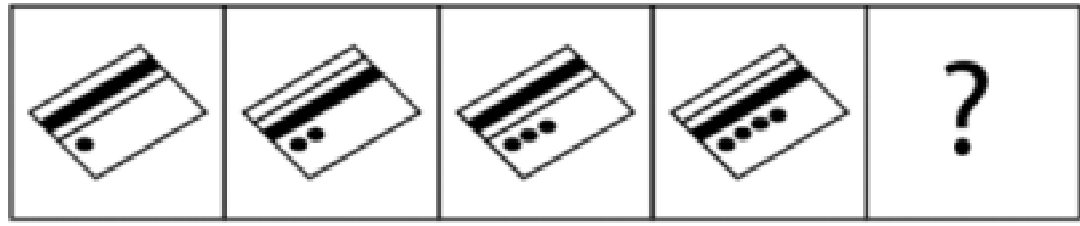

A.



B.



C.



D.





E.



www.riollearning.com

5.

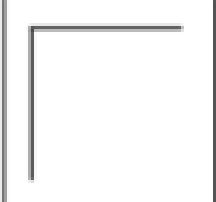
¿Cuál es la figura que falta?

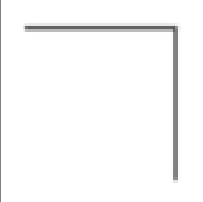
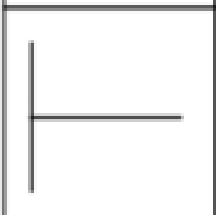
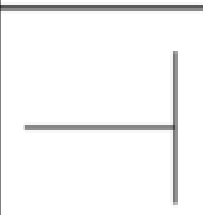
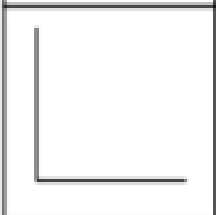
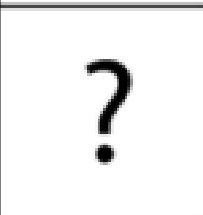

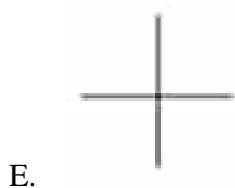
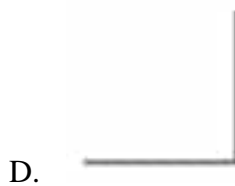
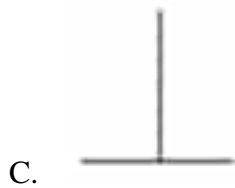
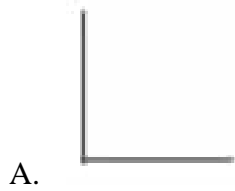



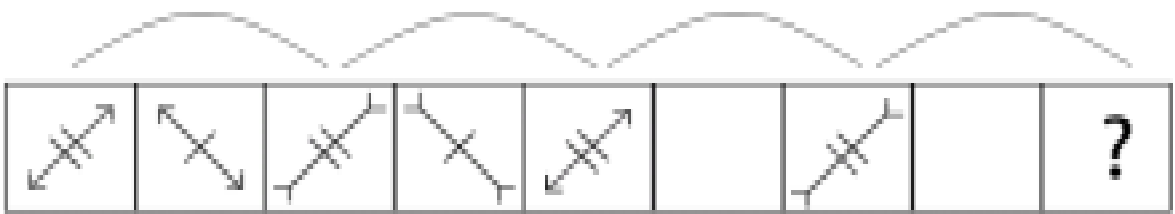

www.riollearning.com

6.

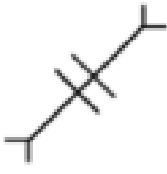
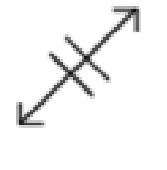
¿Cuál es la figura que falta?

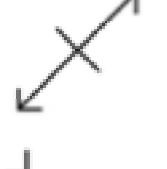



- A. 
- B. 
- C. 
- D. 
- E. 

7.

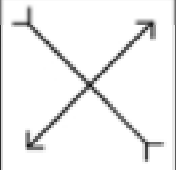
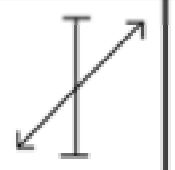
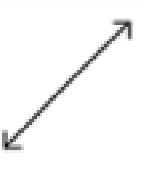
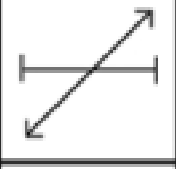
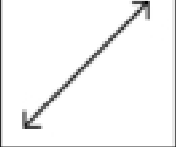
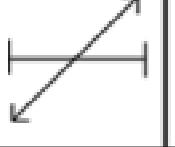
¿Cuál es la figura que falta?

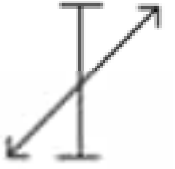
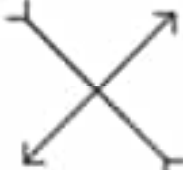
		
		
		?

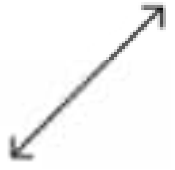
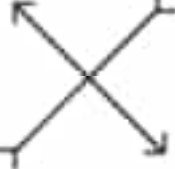
- A. 
- B. 
- C. 
- D. 
- E. 

www.riollearning.com

8.

¿Cuál es la figura que falta?

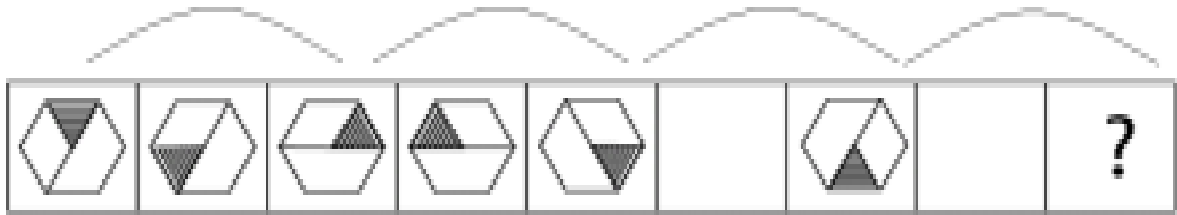

A.



B.



C.



D.



E.



9.

¿Cuál es la figura que falta?

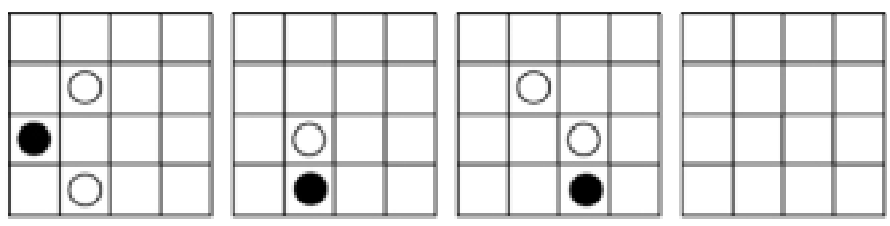

A.

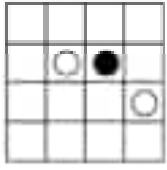

B.

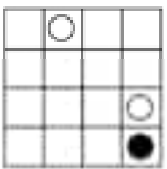

C.

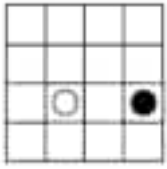

D.

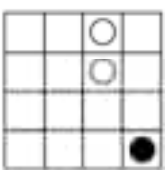

E.

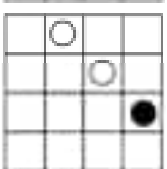

10.

¿Cuál es la figura que falta?

	?	

A.



B.



C.



D.



E.



11.

¿Cuál es la figura que falta?

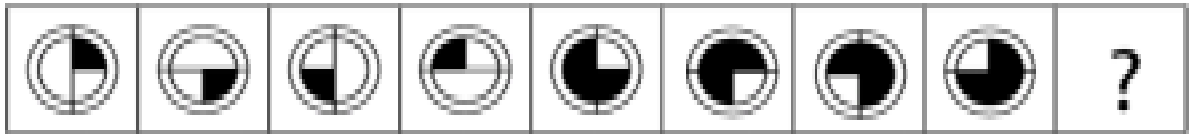

A.

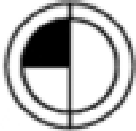

B.



C.



D.







E.

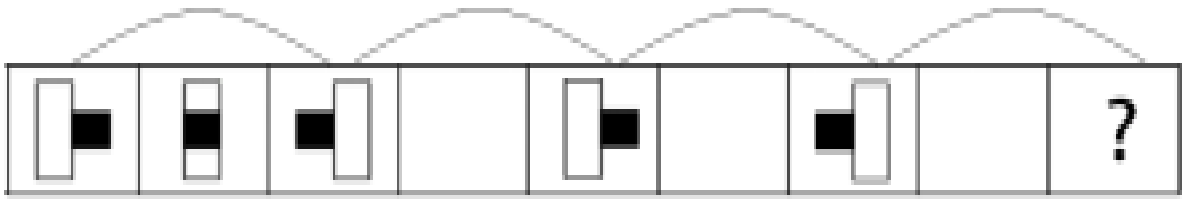

12.

¿Cuál es la figura que falta?

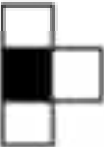
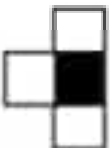

- A. 
- B. 
- C. 
- D. 
- E. 

13.

¿Cuál es la figura que falta?

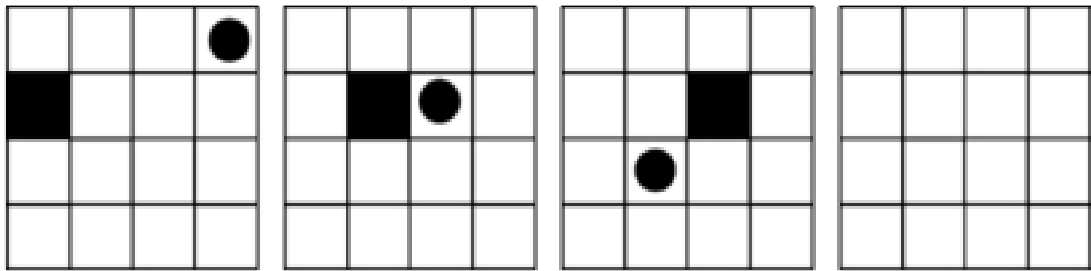

A.

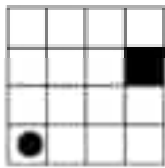

B.

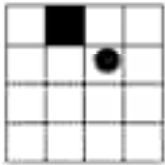

C.

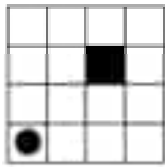

D.

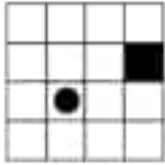



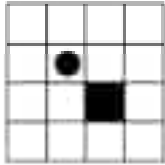



E.

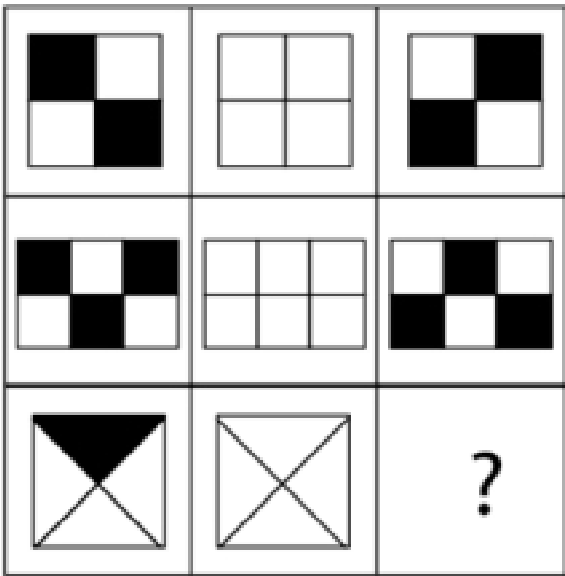

14.

¿Cuál es la figura que falta?



- A. 
- B. 
- C. 
- D. 
- E. 

15.

¿Cuál es la figura que falta?

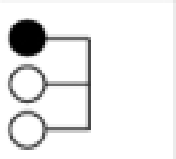
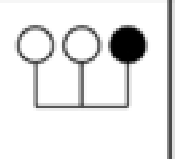
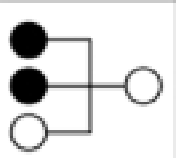
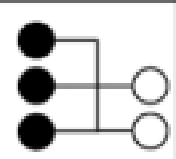
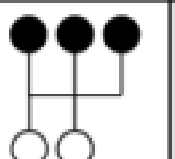
		
		
		?

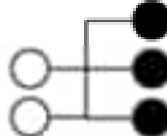
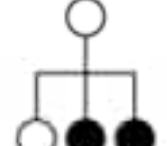
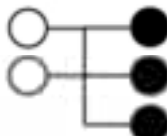
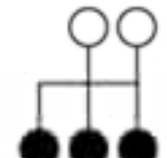
- A. 
- B. 
- C. 
- D. 
- E. 

16.

¿Cuál es la figura que falta?

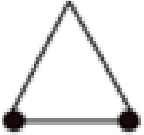
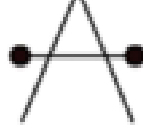
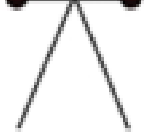
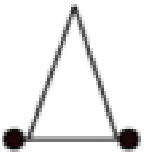
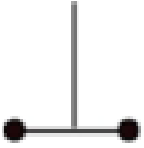
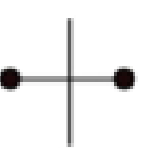
		
		
		?

A.

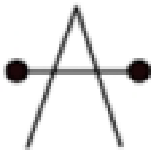

B.

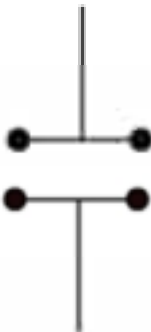

C.

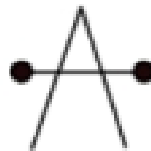

D.



E.

www.riollearning.com

17.

¿Cuál es la figura que falta?

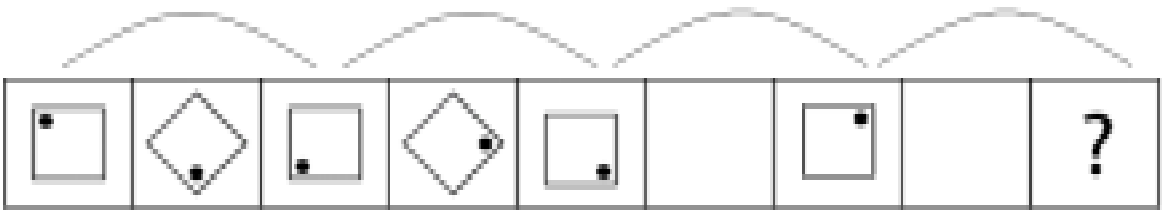

A.

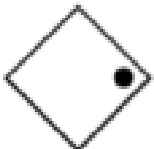

B.

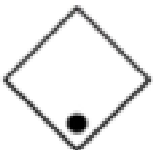

C.

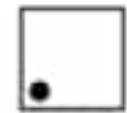

D.

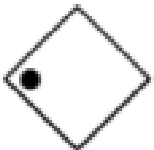

E.

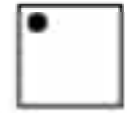



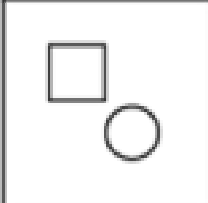
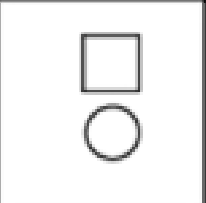
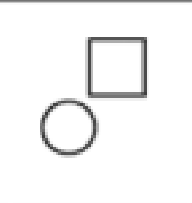
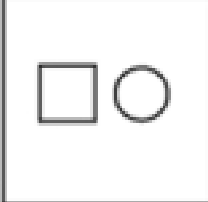
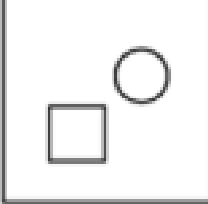
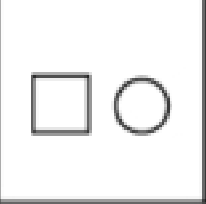

www.riollearning.com

18.

¿Cuál es la figura que falta?

		
		
		?

- A. 
- B. 
- C. 
- D. 
- E. 

19.

¿Cuál es la figura que falta?

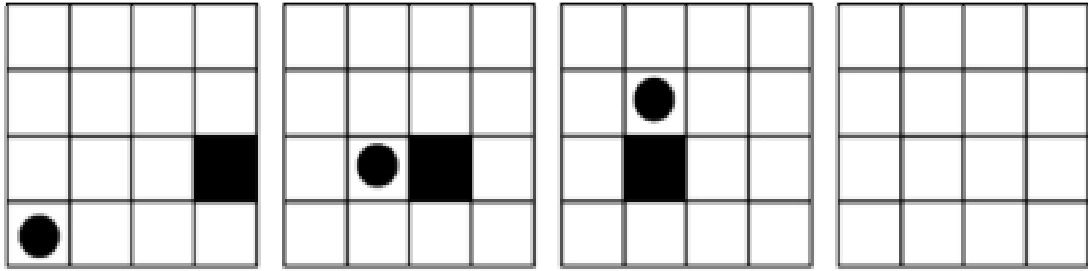

A.

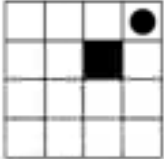

B.

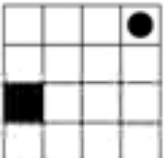

C.

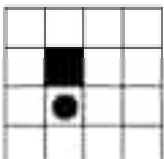

D.

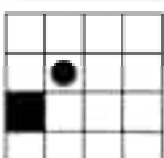

E.

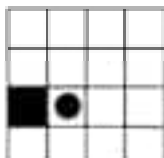





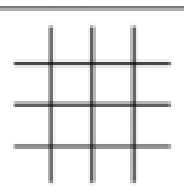
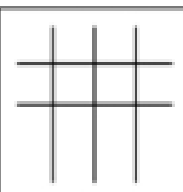
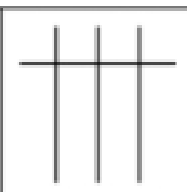
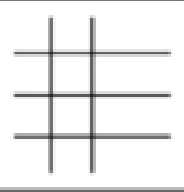
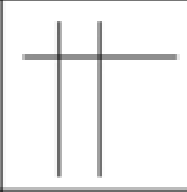
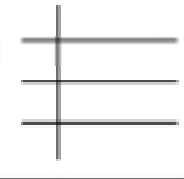

20.

¿Cuál es la figura que falta?

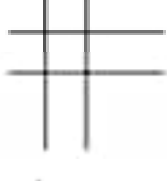
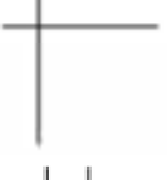



		
		
		?

- A. 
- B. 
- C. 
- D. 
- E. 

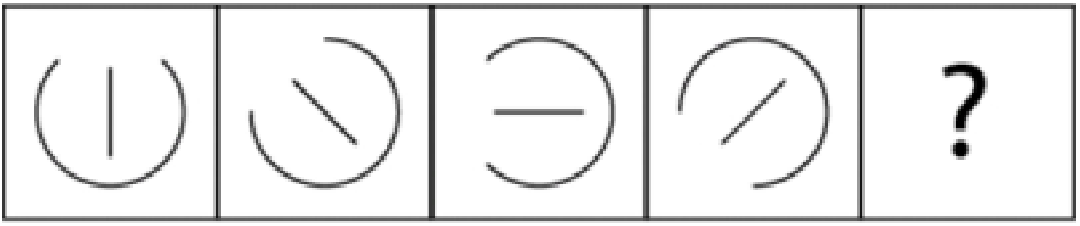
21.

¿Cuál es la figura que falta?







- A. 
- B. 
- C. 
- D. 
- E. 

www.riollearning.com

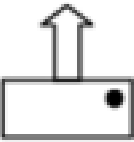
22.

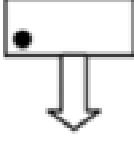
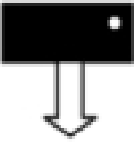
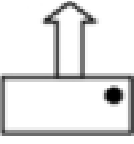
¿Cuál es la figura que falta?

		
		
		?

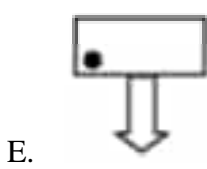
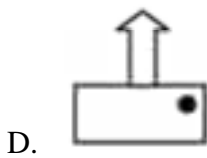
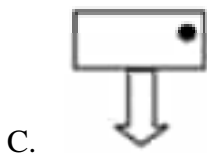
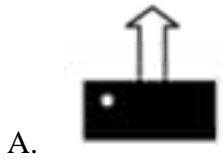

23.

¿Cuál es la figura que falta?

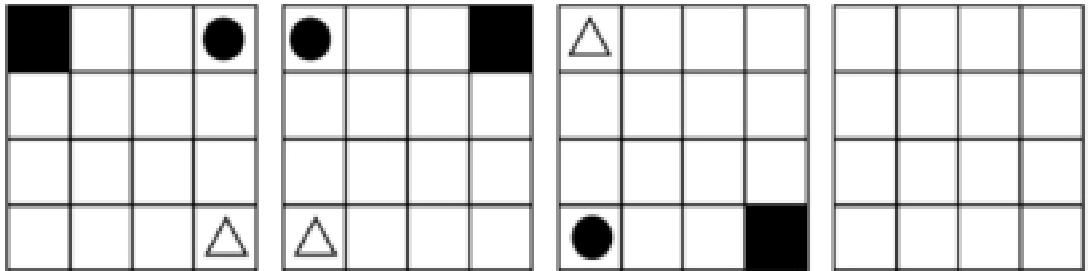

A.

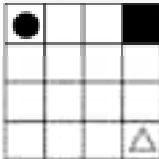

B.

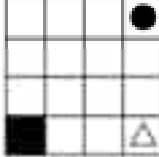

C.

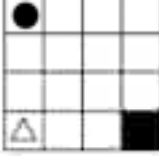

D.

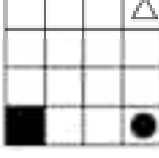

E.

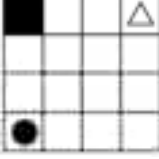

24.

¿Cuál es la figura que falta?

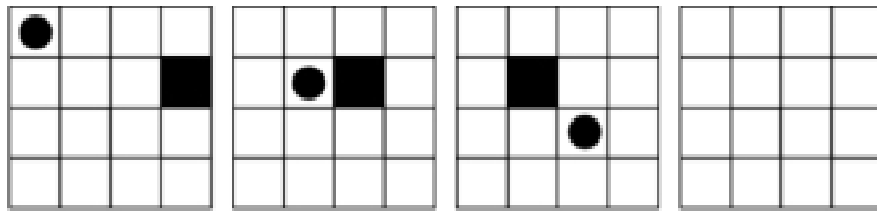

A.

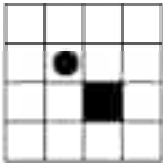

B.

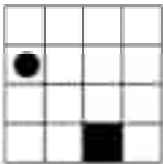

C.

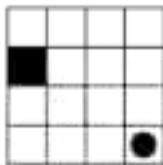

D.

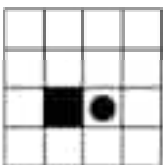

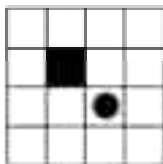

E.

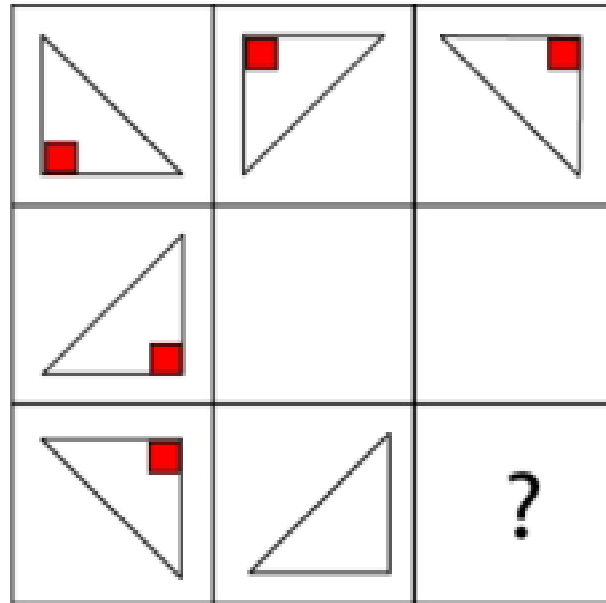

25.

¿Cuál es la figura que falta?

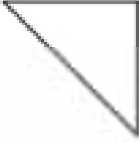
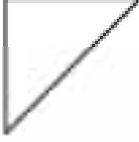
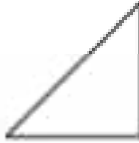

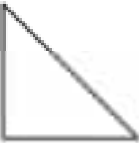



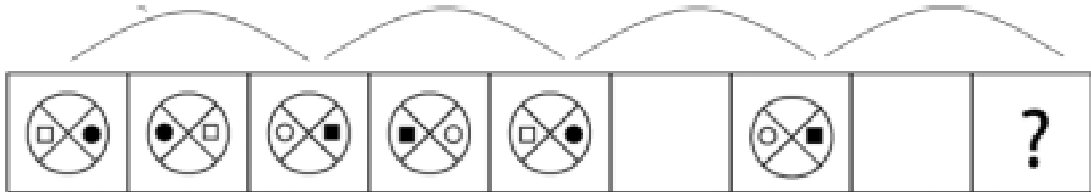

- A. 
- B. 
- C. 
- D. 
- E. 

www.riollearning.com

26.

¿Cuál es la figura que falta?



- A. 
- B. 
- C. 
- D. 
- E. 

27.

¿Cuál es la figura que falta?

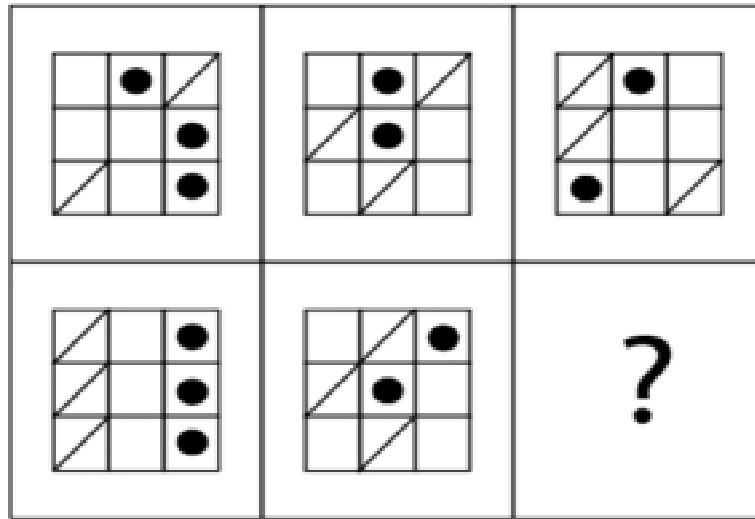

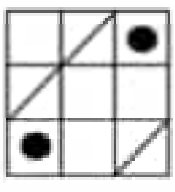

A.

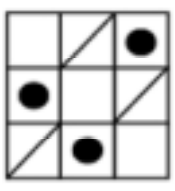

B.

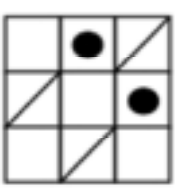

C.

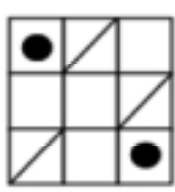

D.

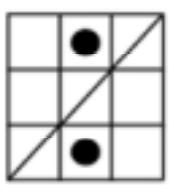

E.

28.

¿Cuál es la figura que falta?

A.



B.

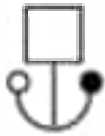

C.



D.



E.



29.

¿Cuál es la figura que falta?

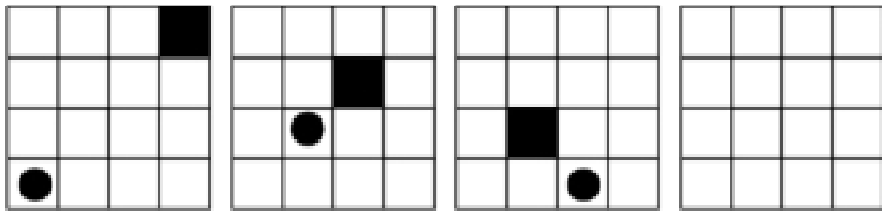

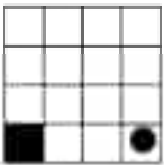
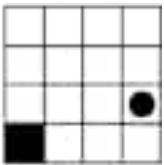
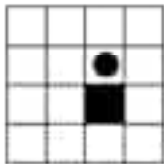
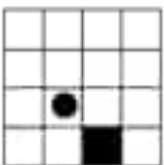
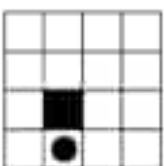
- A. 
- B. 
- C. 
- D. 
- E. 

30.

¿Cuál es la figura que falta?

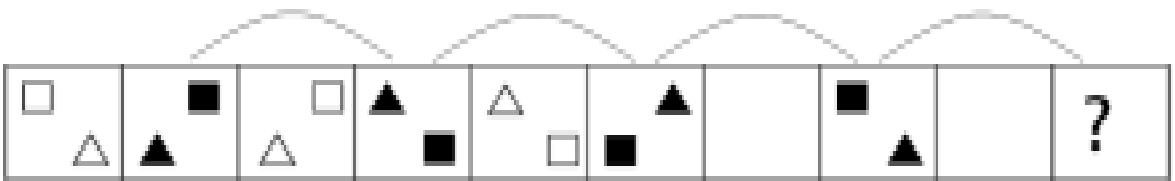

- A.
- B.
- C.
- D.
- E.

31.

¿Cuál es la figura que falta?

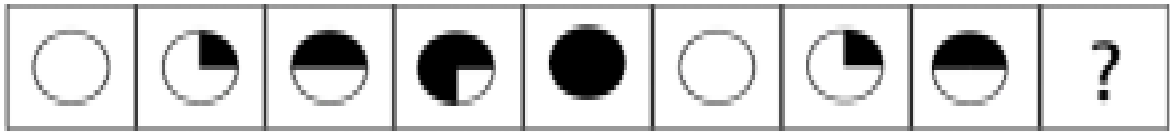

A.

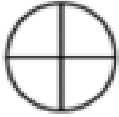

B.



C.



D.



E.



32.

¿Cuál es la figura que falta?

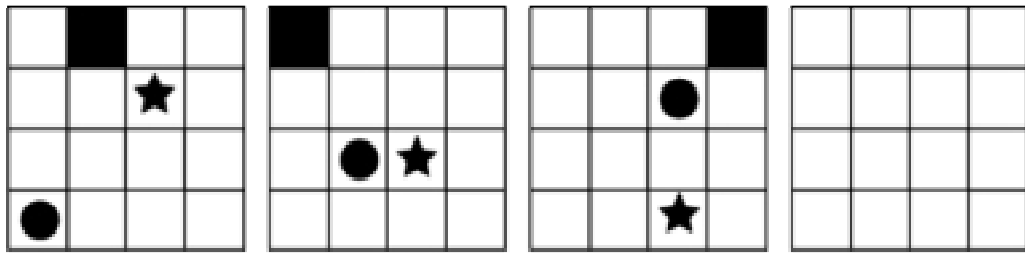

A.

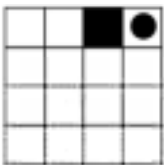

B.

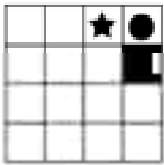

C.

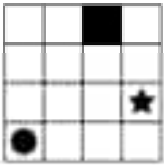

D.

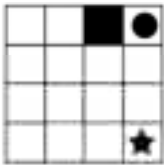

E.

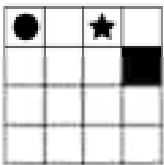

33.



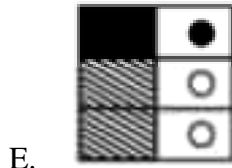
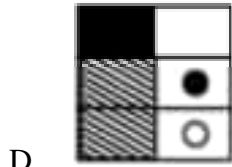
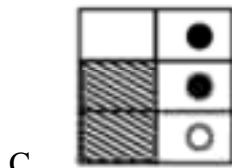
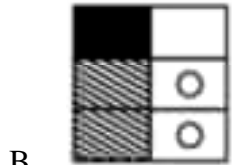
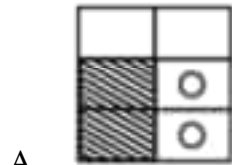
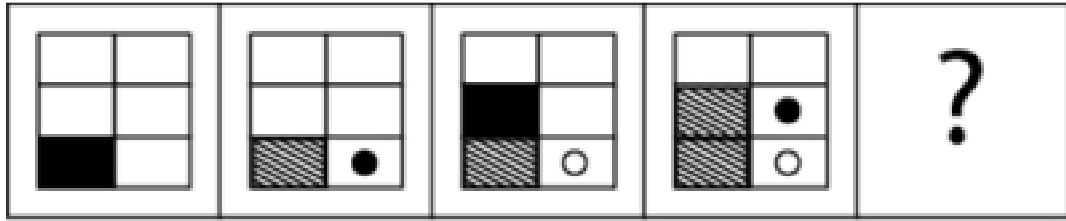

¿Cuál es la figura que falta?

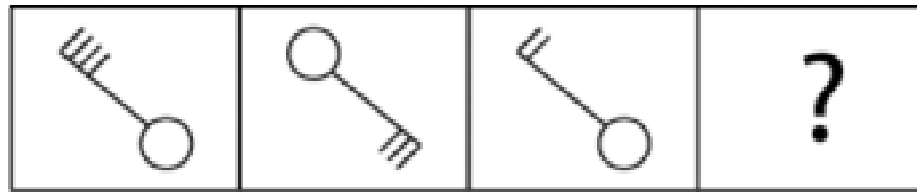

34.

¿Cuál es la figura que falta?

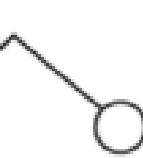

- A. 
- B. 
- C. 
- D. 
- E. 

www.riollearning.com

35.

¿Cuál es la figura que falta?

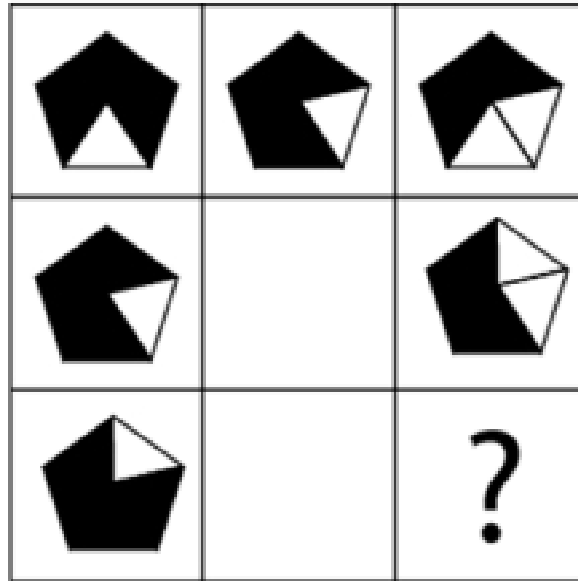

- A.
- B.
- C.
- D.
- E.

36.

¿Cuál es la figura que falta?

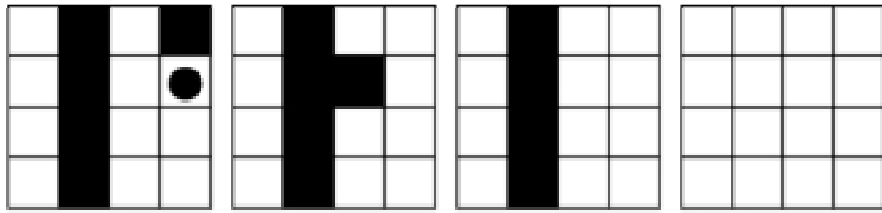

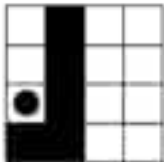
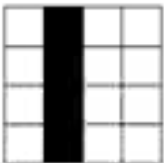
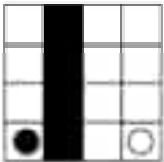
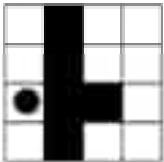
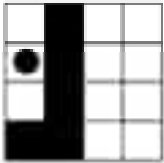
- A. 
- B. 
- C. 
- D. 
- E. 

37.

¿Cuál es la figura que falta?

		?

- A.
- B.
- C.
- D.
- E.

www.riollearning.com

38.

¿Cuál es la figura que falta?

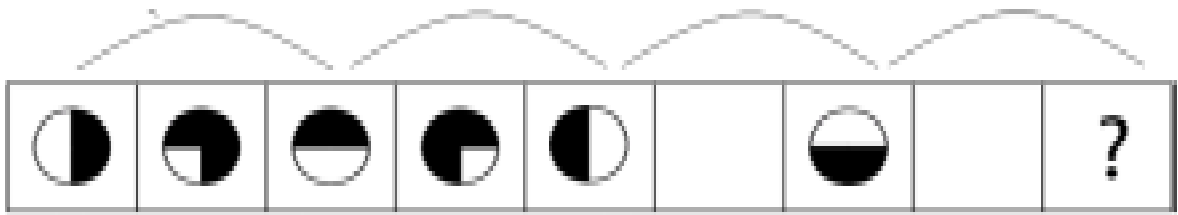

A.



B.



C.



D.



E.



39.

¿Cuál es la figura que falta?









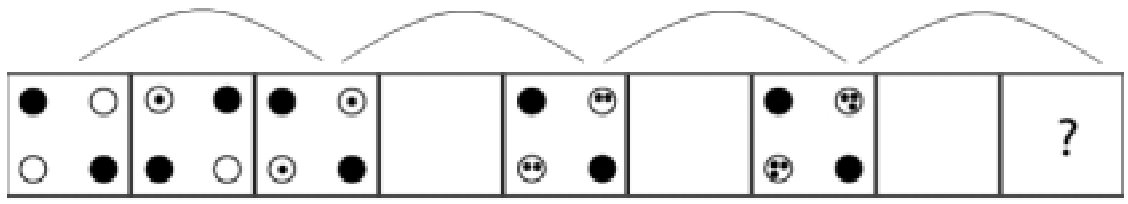

		?

- A.
- B.
- C.
- D.
- E.

40.

¿Cuál es la figura que falta?



- A.  
- B.  
- C.  
- D.  
- E.  

41.

¿Cuál es la figura que falta?

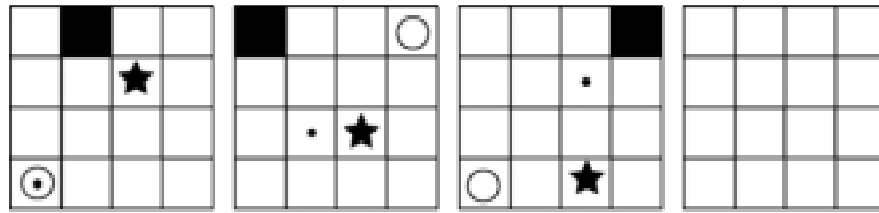

A.

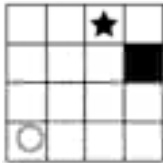

B.

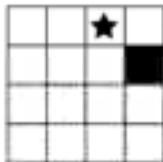

C.

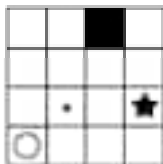

D.

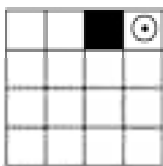

E.

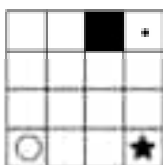

42.

¿Cuál es la figura que falta?

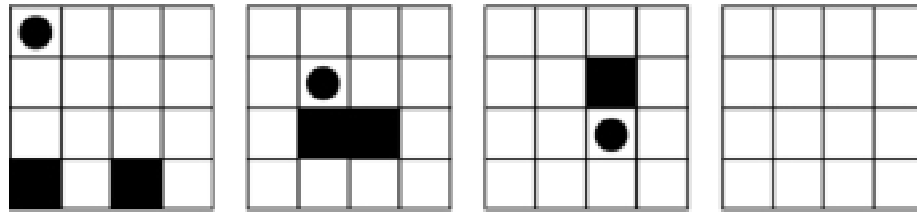

A.

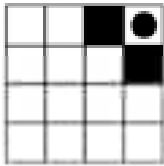

B.

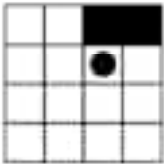

C.

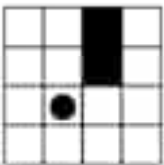

D.

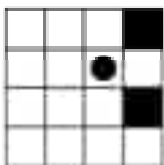

E.

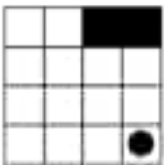

www.riollearning.com

43.

¿Cuál es la figura que falta?

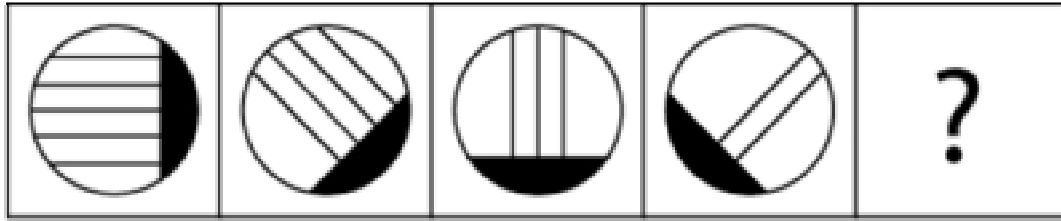

- A.
- B.
- C.
- D.
- E.

44.

¿Cuál es la figura que falta?

	?	

- A.
- B.
- C.
- D.
- E.

45.

¿Cuál es la figura que falta?

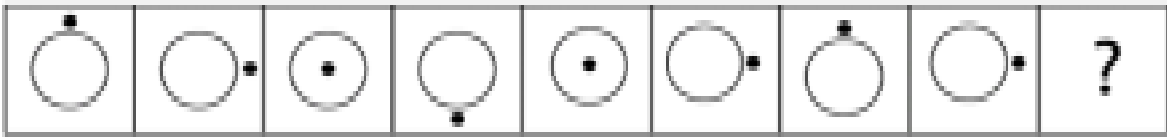

A.



B.

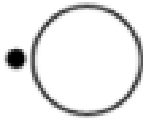

C.

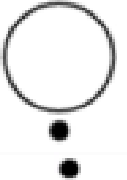

D.

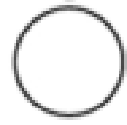

E.

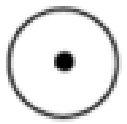

46.

¿Cuál es la figura que falta?

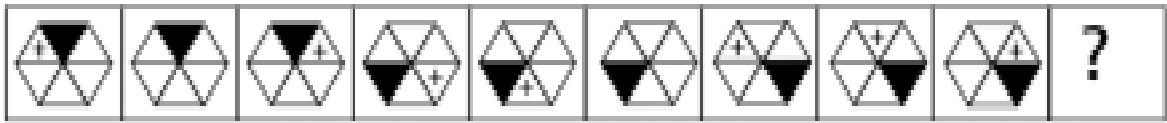

A.

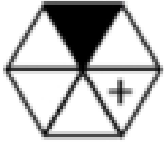

B.

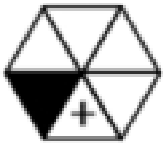

C.

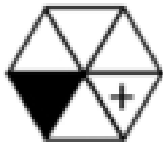

D.

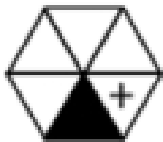

E.



47.

¿Cuál es la figura que falta?







		?

- A.
- B.
- C.
- D.
- E.

www.riollearning.com

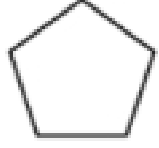
48.

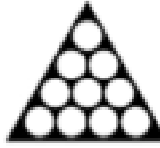
¿Cuál es la figura que falta?

A.



B.



C.



D.



E.



www.riollearning.com

49.

¿Cuál es la figura que falta?

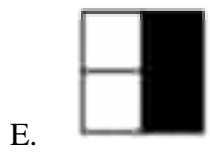
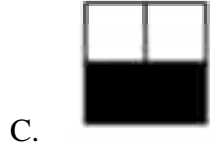
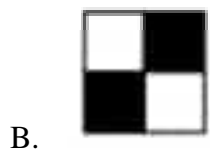
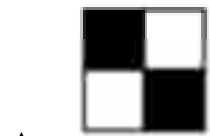
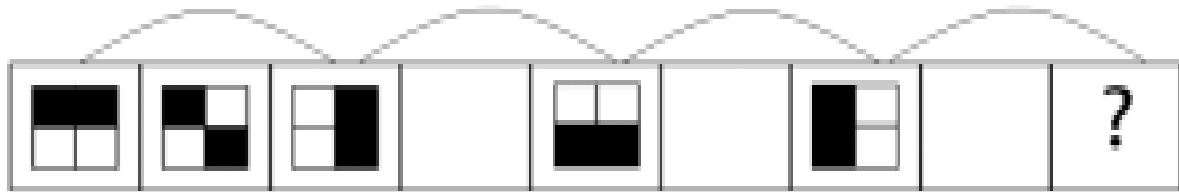





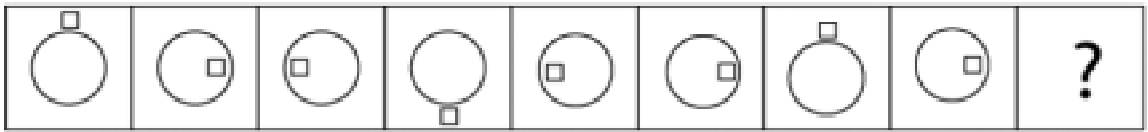

50.

¿Cuál es la figura que falta?

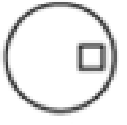

- A. 
- B. 
- C. 
- D. 
- E. 

51.

¿Cuál es la figura que falta?

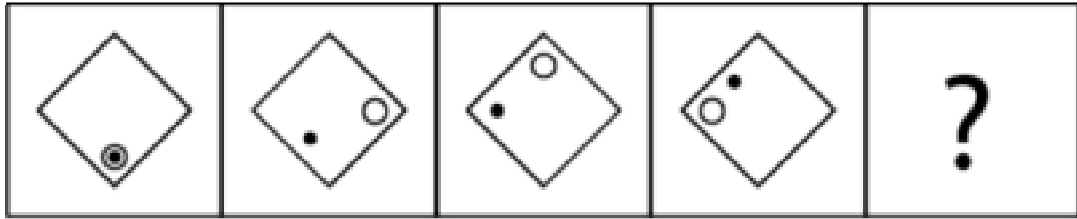

A.



B.

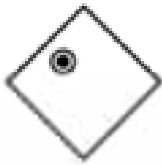

C.



D.



E.

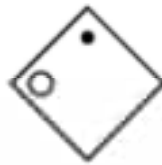

www.riollearning.com

52.

¿Cuál es la figura que falta?

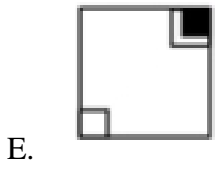
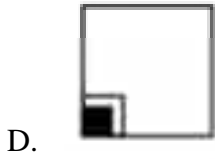
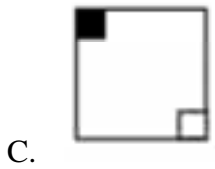
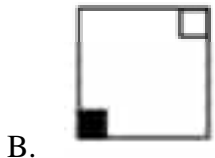
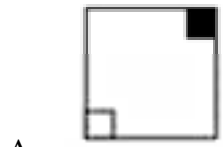
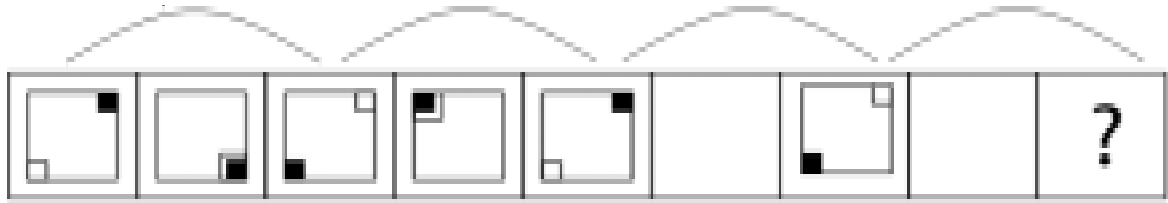

53.

¿Cuál es la figura que falta?

		<p>?</p>

- A.
- B.
- C.
- D.
- E.

54.

¿Cuál es la figura que falta?

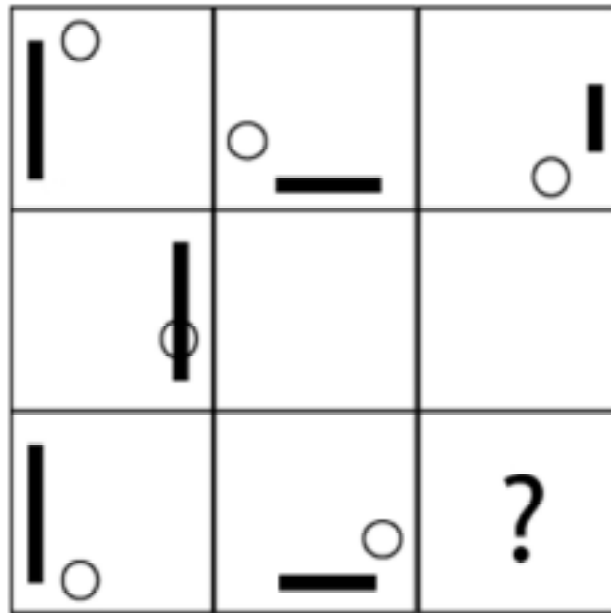

A.



B.



C.







D.





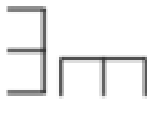
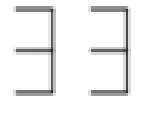

E.

55.

¿Cuál es la figura que falta?

- A. 
- B. 
- C. 
- D. 
- E. 

56.

¿Cuál es la figura que falta?

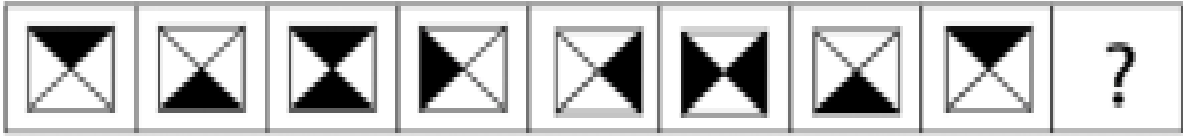

A.



B.



C.



D.



E.



www.riollearning.com

57.

¿Cuál es la figura que falta?

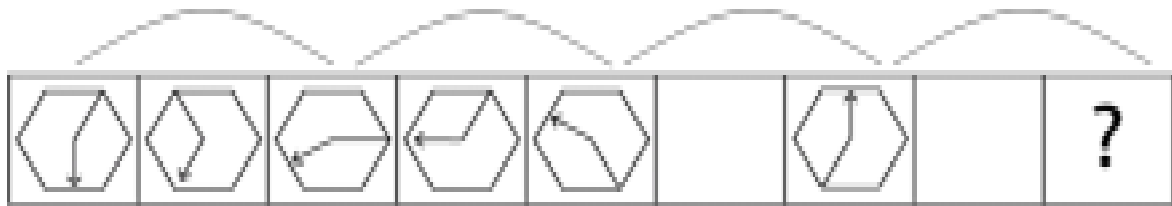

A.



B.

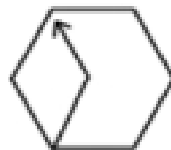

C.

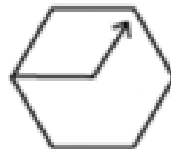

D.

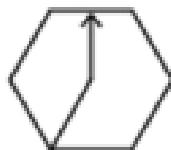

E.



58.

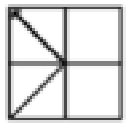
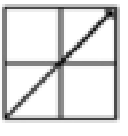
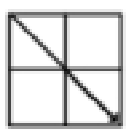
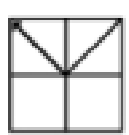
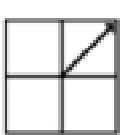

¿Cuál es la figura que falta?

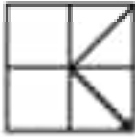
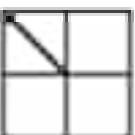
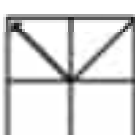
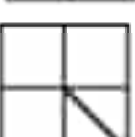
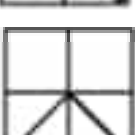

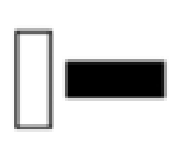
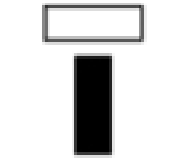
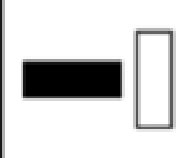
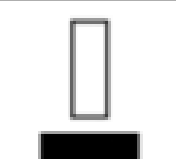
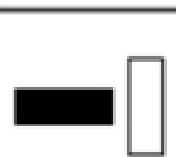

		
		
		?

- A. 
- B. 
- C. 
- D. 
- E. 

59.

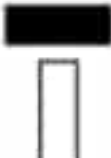
¿Cuál es la figura que falta?

		
		
		?

- A. 
- B. 
- C. 
- D. 
- E. 

60.

¿Cuál es la figura que falta?

		?

- A.
- B.
- C.
- D.
- E.

www.riollearning.com

61.

¿Cuál es la figura que falta?

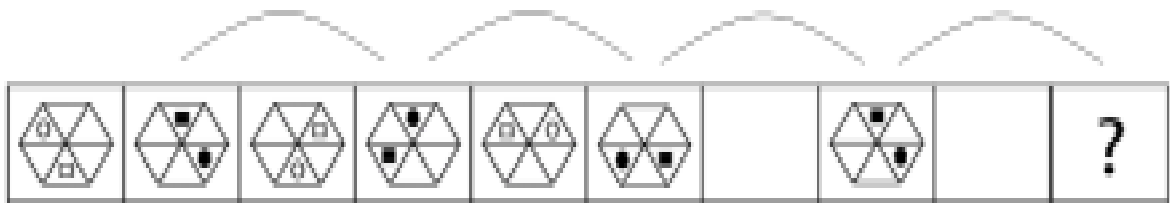

A.

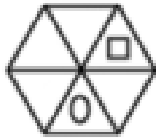

B.



C.

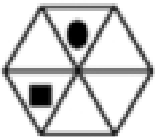

D.

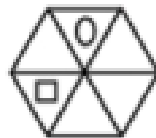

E.



62.

¿Cuál es la figura que falta?

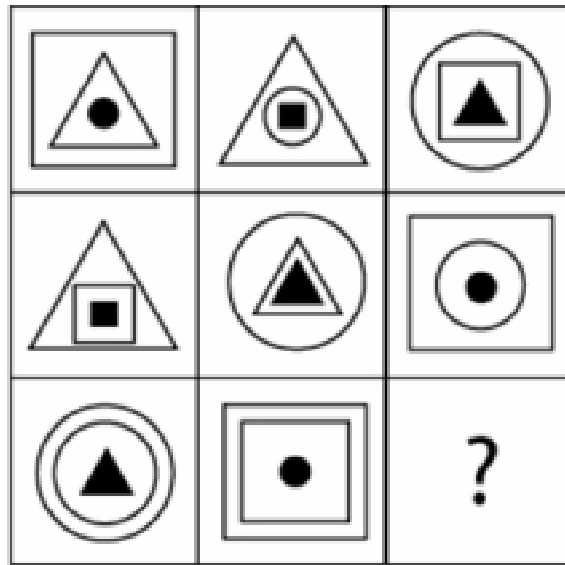

A.



B.



C.



D.



E.



www.riollearning.com

63.

¿Cuál es la figura que falta?

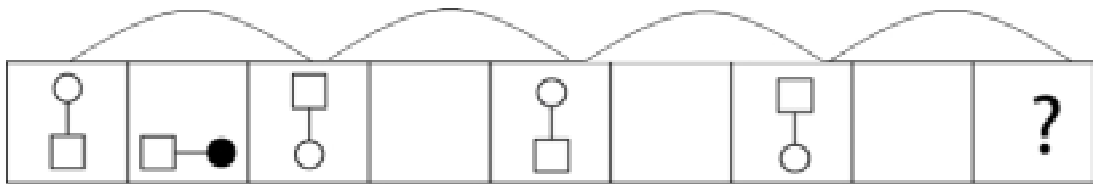

64.

¿Cuál es la figura que falta?

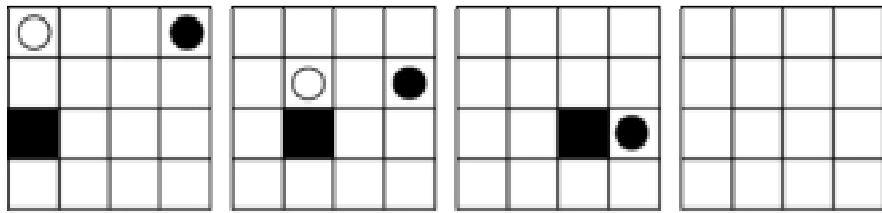

A.

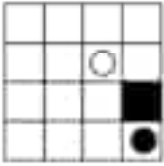

B.

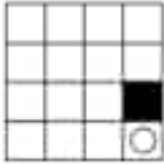

C.

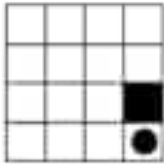

D.

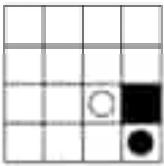



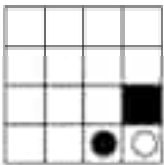



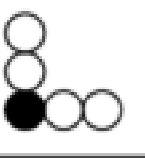
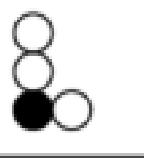
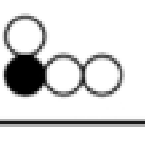

E.



65.

¿Cuál es la figura que falta?

		
		
		?

- A. 
- B. 
- C. 
- D. 
- E. 

66.

¿Cuál es la figura que falta?

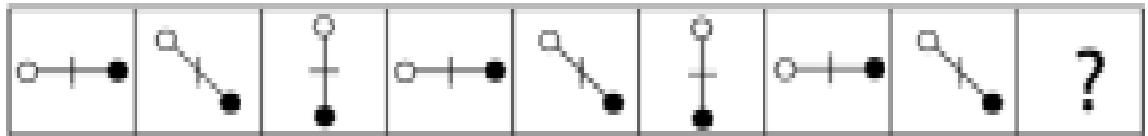

- A.
- B.
- C.
- D.
- E.

67.

¿Cuál es la figura que falta?

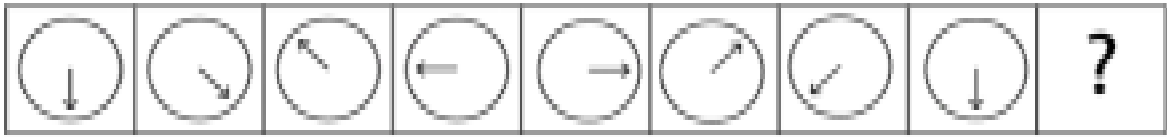

A.

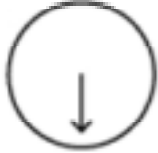

B.

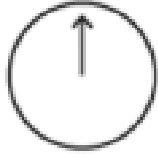

C.



D.



E.



68.

¿Cuál es la figura que falta?

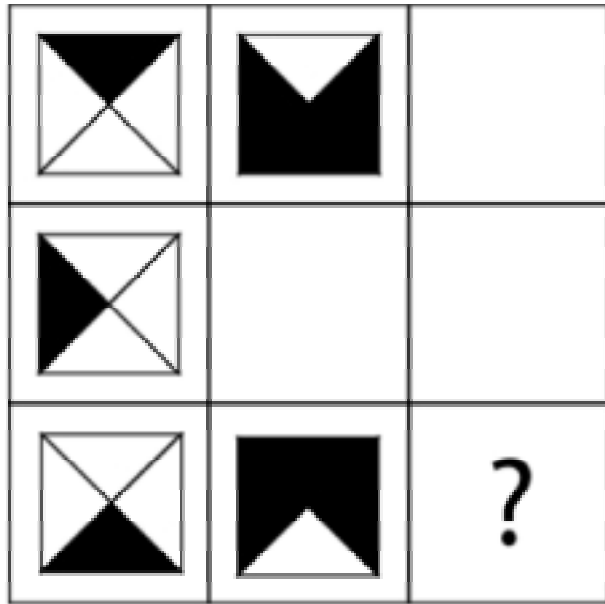

A.



B.



C.



D.



E.



69.

¿Cuál es la figura que falta?

		?

- A.
- B.
- C.
- D.
- E.

70.

¿Cuál es la figura que falta?

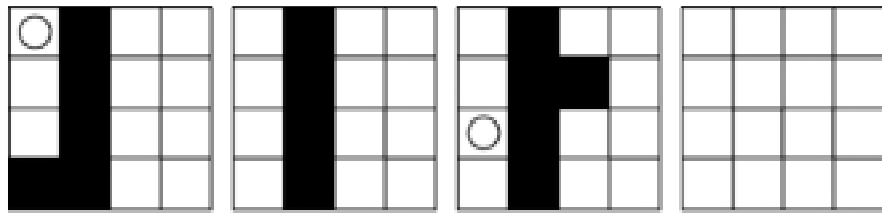

A.

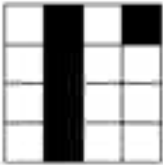

B.

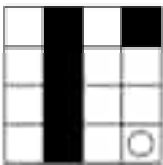

C.

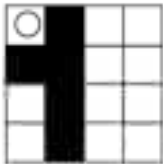

D.

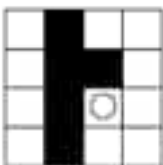

E.

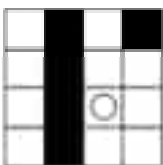

www.riollearning.com

71.

¿Cuál es la figura que falta?

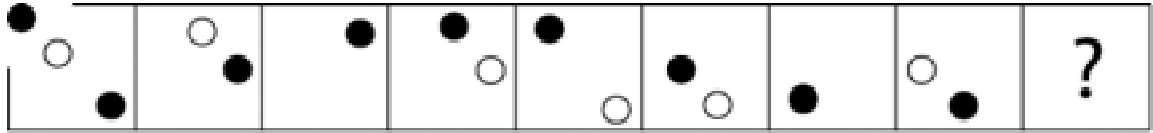

- A. ●
●
- B. ○
○
- C. ●
●
- D. ○
- E. ●



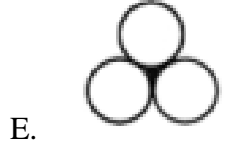
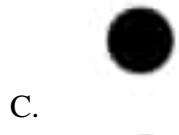
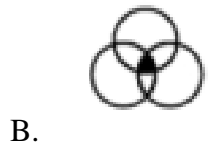
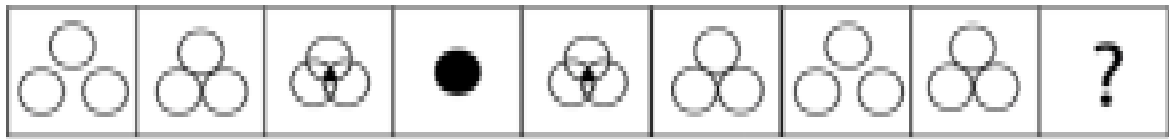

72.





¿Cuál es la figura que falta?

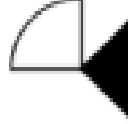

73.



¿Cuál es la figura que falta?



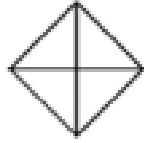
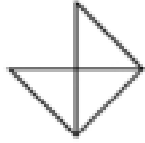
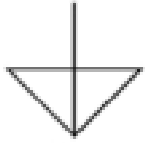
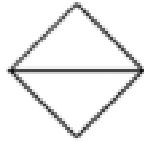

		
		
		?

- A. 
- B. 
- C. 
- D. 
- E. 

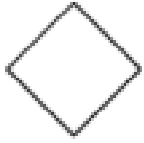
74.

¿Cuál es la figura que falta?

		
		
		?

- A. 
- B. 
- C. 
- D. 
- E. 

75.

¿Cuál es la figura que falta?

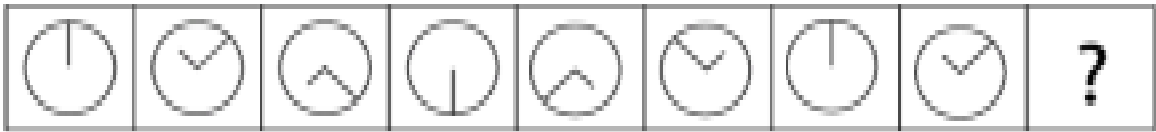

A.



B.



C.



D.



E.



www.riollearning.com

76.

¿Cuál es la figura que falta?

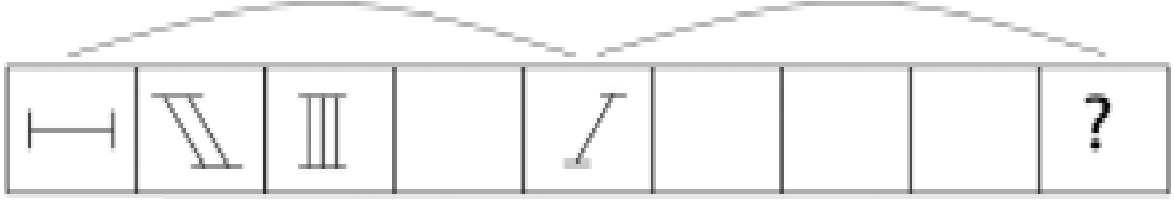

A.



B.



C.



D.

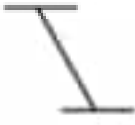



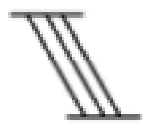



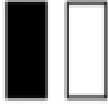
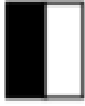

E.

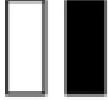

77.

¿Cuál es la figura que falta?

		
		
		?

- A. 
- B. 
- C. 
- D. 
- E. 





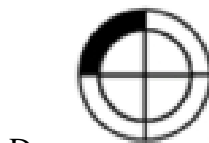
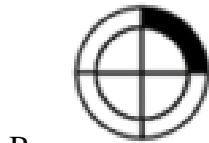
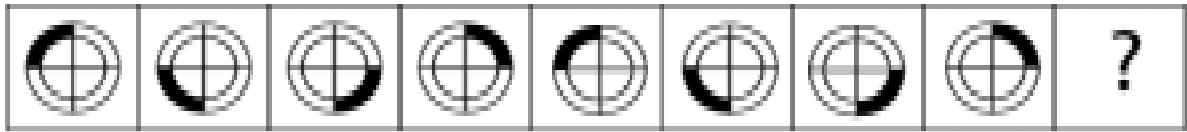

78.

¿Cuál es la figura que falta?

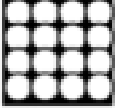
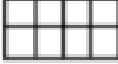

79.

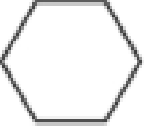
¿Cuál es la figura que falta?

A.



B.



C.

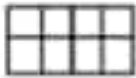

D.



E.



80.

¿Cuál es la figura que falta?

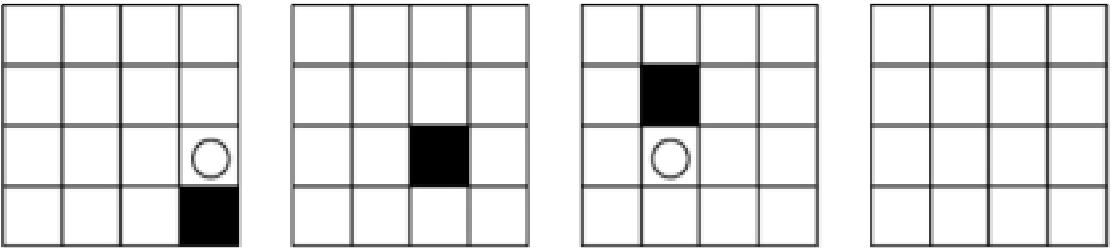

A.

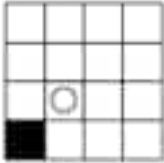

B.

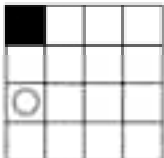

C.

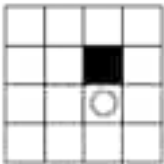

D.

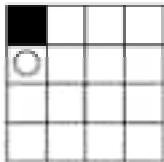

E.

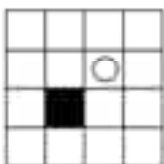

81.

¿Cuál es la figura que falta?

A.

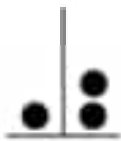

B.

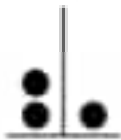

C.

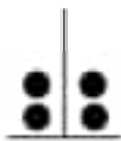

D.



E.

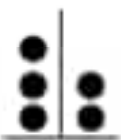

82.

¿Cuál es la figura que falta?

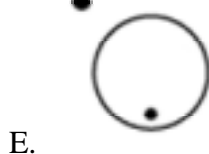
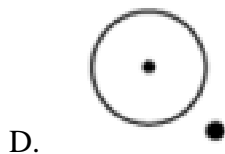
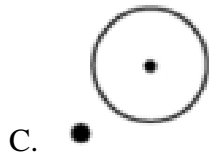
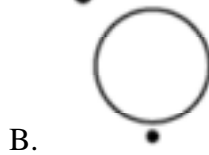
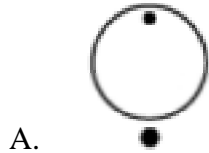
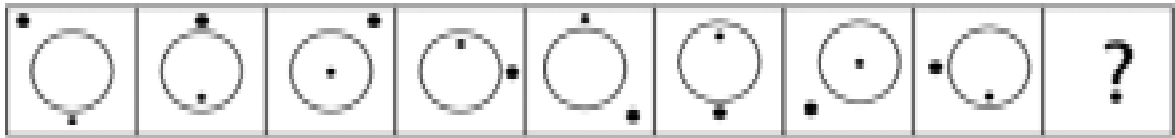

www.riollearning.com

83.

¿Cuál es la figura que falta?

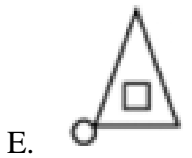
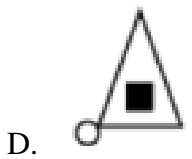
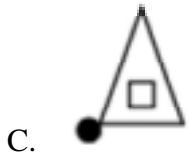
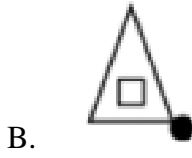
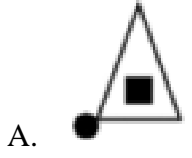
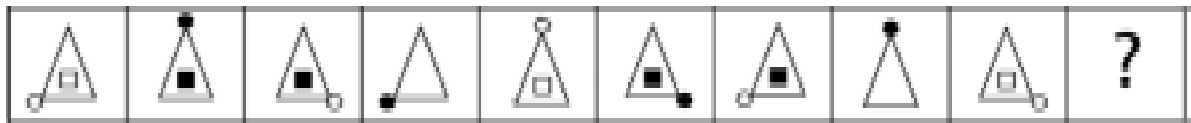

84.

¿Cuál es la figura que falta?

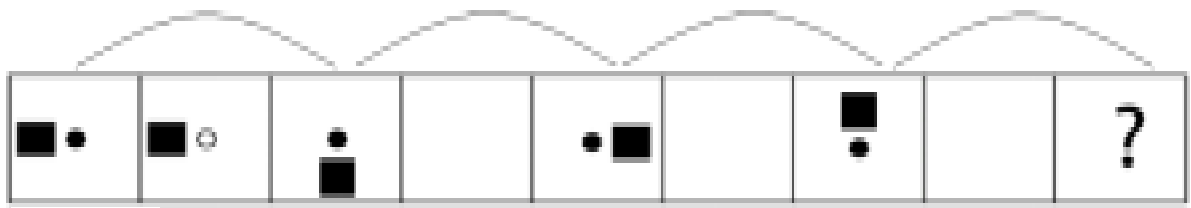

A.



B.



C.



D.



E.



85.

¿Cuál es la figura que falta?

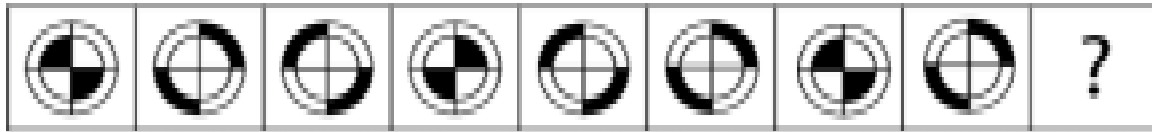

A.



B.



C.



D.









E.

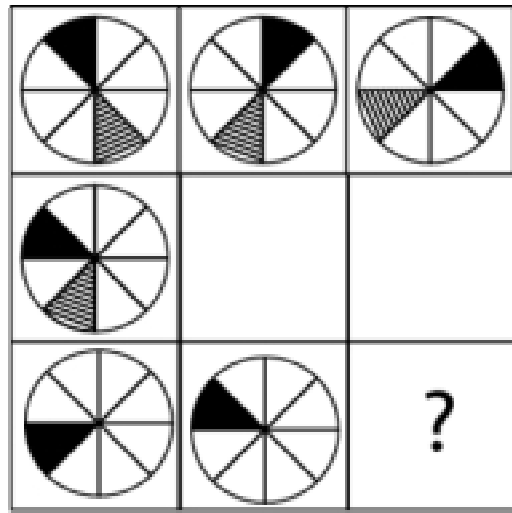

86.

¿Cuál es la figura que falta?

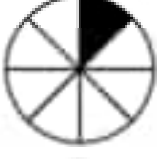

- A. 
- B. 
- C. 
- D. 
- E. 

87.

¿Cuál es la figura que falta?

		?

- A.
- B.
- C.
- D.
- E.

88.

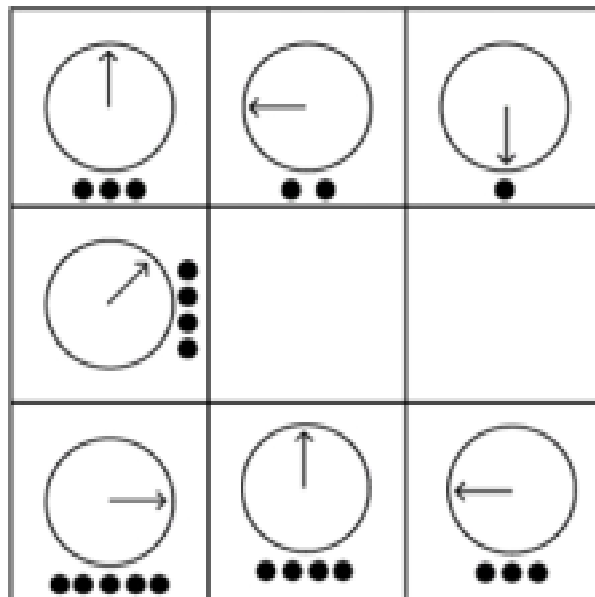

¿Cuál es la figura que falta?





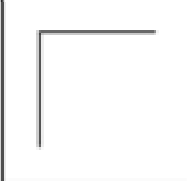
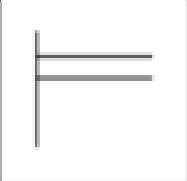
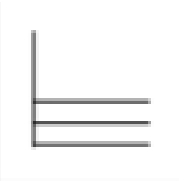
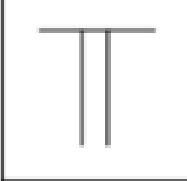
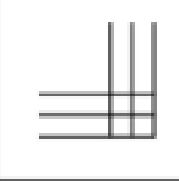
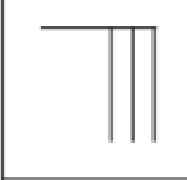

- A.
- B.
- C.
- D.
- E.

89.

¿Cuál es la figura que falta?

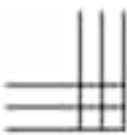



- A. 
- B. 
- C. 
- D. 
- E. 

www.riollearning.com

90.

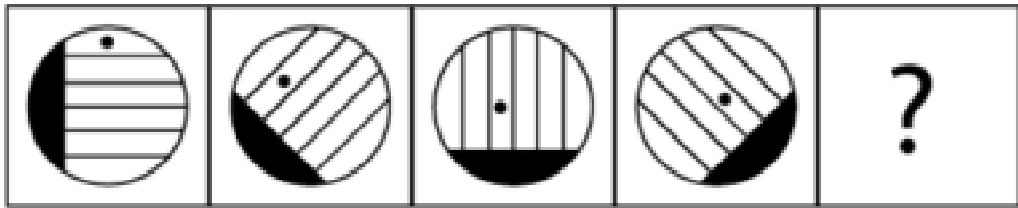
¿Cuál es la figura que falta?

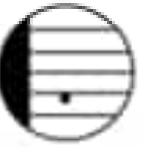
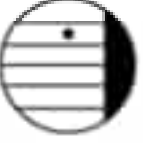

- A. 
- B. 
- C. 
- D. 
- E. 

91.



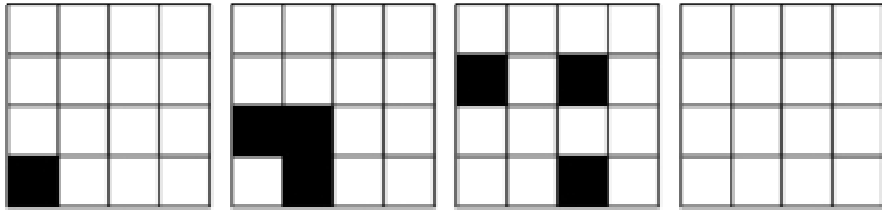

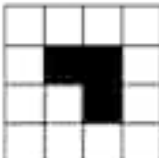
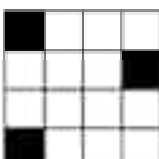
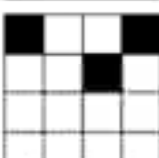
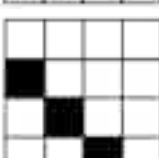
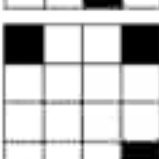

¿Cuál es la figura que falta?





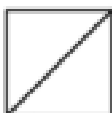

- A. 
- B. 
- C. 
- D. 
- E. 

92.

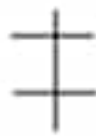
¿Cuál es la figura que falta?

- A. 
- B. 
- C. 
- D. 
- E. 

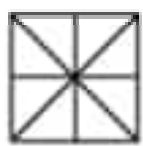
www.riollearning.com

93.

¿Cuál es la figura que falta?





		?

- A.
- B.
- C.
- D.
- E.

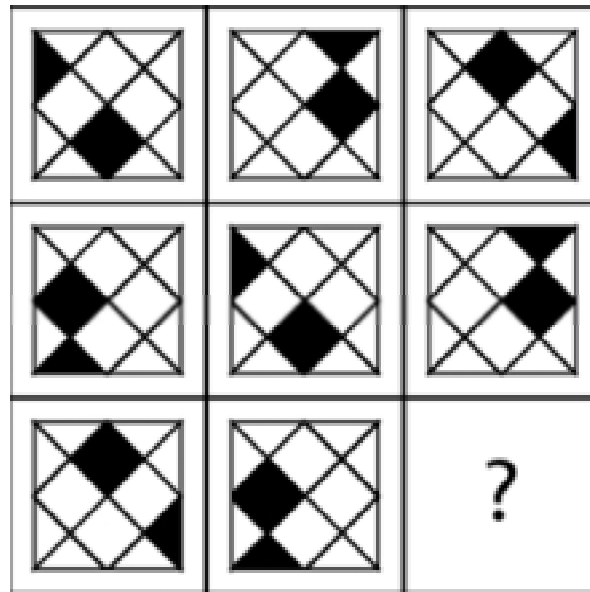
94.

¿Cuál es la figura que falta?



- A. 
- B. 
- C. 
- D. 
- E. 

95.

¿Cuál es la figura que falta?

A.

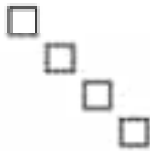

B.



C.



D.



E.



96.

¿Cuál es la figura que falta?

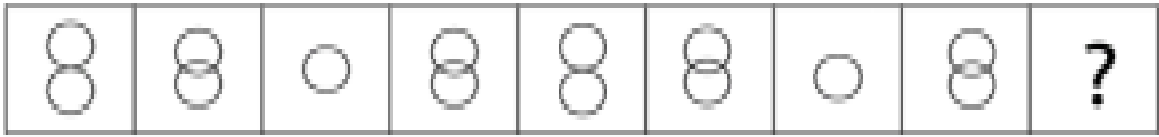

A.



B.



C.



D.



E.

97.

¿Cuál es la figura que falta?

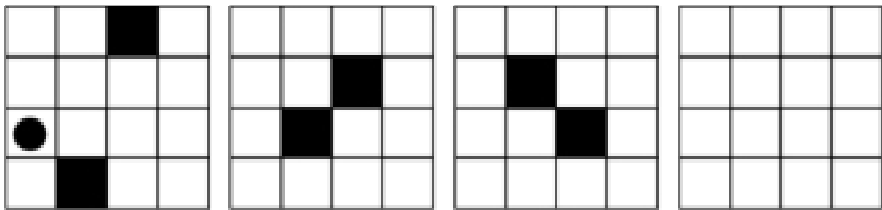

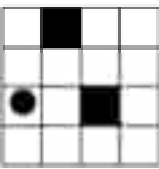
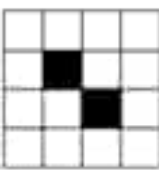
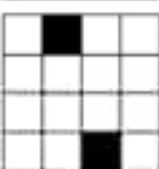
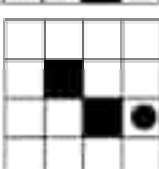
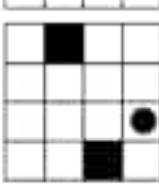





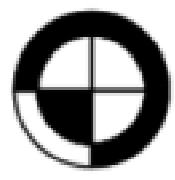
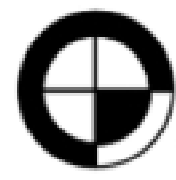

- A. 
- B. 
- C. 
- D. 
- E. 

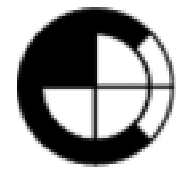
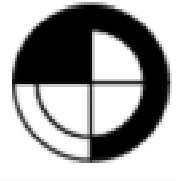
www.riollearning.com

98.

¿Cuál es la figura que falta?

		
		
		?

- A. 
- B. 
- C. 
- D. 
- E. 

99.

¿Cuál es la figura que falta?

		?

- A.
- B.
- C.
- D.
- E.



100.

¿Cuál es la figura que falta?

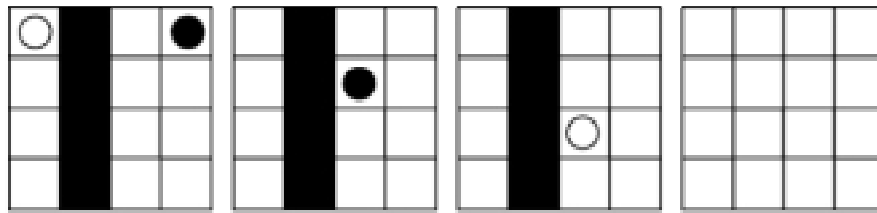

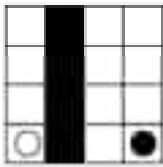
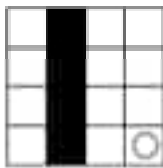
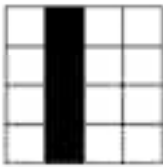
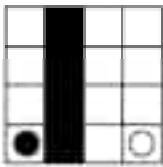
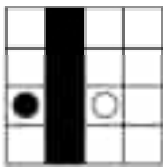
- A. 
- B. 
- C. 
- D. 
- E. 

ACCESO A LA EDUCACIÓN SUPERIOR TAE100_001

Answer Section

MULTIPLE CHOICE

- | | |
|------------|--------|
| 1. ANS: A | PTS: 1 |
| 2. ANS: E | PTS: 1 |
| 3. ANS: D | PTS: 1 |
| 4. ANS: D | PTS: 1 |
| 5. ANS: D | PTS: 1 |
| 6. ANS: B | PTS: 1 |
| 7. ANS: B | PTS: 1 |
| 8. ANS: B | PTS: 1 |
| 9. ANS: E | PTS: 1 |
| 10. ANS: A | PTS: 1 |
| 11. ANS: C | PTS: 1 |
| 12. ANS: A | PTS: 1 |
| 13. ANS: A | PTS: 1 |
| 14. ANS: E | PTS: 1 |
| 15. ANS: D | PTS: 1 |
| 16. ANS: C | PTS: 1 |
| 17. ANS: E | PTS: 1 |
| 18. ANS: D | PTS: 1 |
| 19. ANS: B | PTS: 1 |
| 20. ANS: D | PTS: 1 |
| 21. ANS: A | PTS: 1 |
| 22. ANS: E | PTS: 1 |
| 23. ANS: D | PTS: 1 |
| 24. ANS: C | PTS: 1 |
| 25. ANS: E | PTS: 1 |
| 26. ANS: A | PTS: 1 |
| 27. ANS: A | PTS: 1 |
| 28. ANS: B | PTS: 1 |
| 29. ANS: B | PTS: 1 |
| 30. ANS: E | PTS: 1 |
| 31. ANS: D | PTS: 1 |
| 32. ANS: A | PTS: 1 |
| 33. ANS: B | PTS: 1 |
| 34. ANS: A | PTS: 1 |
| 35. ANS: D | PTS: 1 |
| 36. ANS: E | PTS: 1 |
| 37. ANS: E | PTS: 1 |
| 38. ANS: D | PTS: 1 |
| 39. ANS: A | PTS: 1 |
| 40. ANS: A | PTS: 1 |

41.	ANS: D	PTS: 1
42.	ANS: E	PTS: 1
43.	ANS: B	PTS: 1
44.	ANS: D	PTS: 1
45.	ANS: E	PTS: 1
46.	ANS: A	PTS: 1
47.	ANS: E	PTS: 1
48.	ANS: E	PTS: 1
49.	ANS: D	PTS: 1
50.	ANS: E	PTS: 1
51.	ANS: C	PTS: 1
52.	ANS: A	PTS: 1
53.	ANS: C	PTS: 1
54.	ANS: D	PTS: 1
55.	ANS: C	PTS: 1
56.	ANS: D	PTS: 1
57.	ANS: A	PTS: 1
58.	ANS: A	PTS: 1
59.	ANS: C	PTS: 1
60.	ANS: C	PTS: 1
61.	ANS: C	PTS: 1
62.	ANS: D	PTS: 1
63.	ANS: C	PTS: 1
64.	ANS: C	PTS: 1
65.	ANS: B	PTS: 1
66.	ANS: E	PTS: 1
67.	ANS: B	PTS: 1
68.	ANS: B	PTS: 1
69.	ANS: B	PTS: 1
70.	ANS: A	PTS: 1
71.	ANS: E	PTS: 1
72.	ANS: B	PTS: 1
73.	ANS: C	PTS: 1
74.	ANS: B	PTS: 1
75.	ANS: E	PTS: 1
76.	ANS: A	PTS: 1
77.	ANS: D	PTS: 1
78.	ANS: D	PTS: 1
79.	ANS: A	PTS: 1
80.	ANS: B	PTS: 1
81.	ANS: B	PTS: 1
82.	ANS: B	PTS: 1
83.	ANS: A	PTS: 1
84.	ANS: E	PTS: 1
85.	ANS: C	PTS: 1

86.	ANS: A	PTS: 1
87.	ANS: A	PTS: 1
88.	ANS: B	PTS: 1
89.	ANS: C	PTS: 1
90.	ANS: C	PTS: 1
91.	ANS: E	PTS: 1
92.	ANS: B	PTS: 1
93.	ANS: A	PTS: 1
94.	ANS: E	PTS: 1
95.	ANS: E	PTS: 1
96.	ANS: E	PTS: 1
97.	ANS: E	PTS: 1
98.	ANS: A	PTS: 1
99.	ANS: E	PTS: 1
100.	ANS: D	PTS: 1



Forma

Test Version

--	--	--	--	--	--	--	--	--	--	--

Nombre: _____

Asignatura: _____

Fecha: _____

A

B

C

D

0 0 0 0 0 0 0 0 0

1 1 1 1 1 1 1 1 1

2 2 2 2 2 2 2 2 2

3 3 3 3 3 3 3 3 3

4 4 4 4 4 4 4 4 4

5 5 5 5 5 5 5 5 5

6 6 6 6 6 6 6 6 6

7 7 7 7 7 7 7 7 7

8 8 8 8 8 8 8 8 8

9 9 9 9 9 9 9 9 9

Cédula - Código

Ejemplo

A B C D E

Calificación

--

- Utilice lápiz para marcar la respuesta.
- Marque un círculo completo
- Borre completamente el círculo para marcar una nueva respuesta

1 <input type="radio"/> A <input type="radio"/> B <input type="radio"/> C <input type="radio"/> D <input type="radio"/> E	21 <input type="radio"/> A <input type="radio"/> B <input type="radio"/> C <input type="radio"/> D <input type="radio"/> E	41 <input type="radio"/> A <input type="radio"/> B <input type="radio"/> C <input type="radio"/> D <input type="radio"/> E	61 <input type="radio"/> A <input type="radio"/> B <input type="radio"/> C <input type="radio"/> D <input type="radio"/> E	81 <input type="radio"/> A <input type="radio"/> B <input type="radio"/> C <input type="radio"/> D <input type="radio"/> E
2 <input type="radio"/> A <input type="radio"/> B <input type="radio"/> C <input type="radio"/> D <input type="radio"/> E	22 <input type="radio"/> A <input type="radio"/> B <input type="radio"/> C <input type="radio"/> D <input type="radio"/> E	42 <input type="radio"/> A <input type="radio"/> B <input type="radio"/> C <input type="radio"/> D <input type="radio"/> E	62 <input type="radio"/> A <input type="radio"/> B <input type="radio"/> C <input type="radio"/> D <input type="radio"/> E	82 <input type="radio"/> A <input type="radio"/> B <input type="radio"/> C <input type="radio"/> D <input type="radio"/> E
3 <input type="radio"/> A <input type="radio"/> B <input type="radio"/> C <input type="radio"/> D <input type="radio"/> E	23 <input type="radio"/> A <input type="radio"/> B <input type="radio"/> C <input type="radio"/> D <input type="radio"/> E	43 <input type="radio"/> A <input type="radio"/> B <input type="radio"/> C <input type="radio"/> D <input type="radio"/> E	63 <input type="radio"/> A <input type="radio"/> B <input type="radio"/> C <input type="radio"/> D <input type="radio"/> E	83 <input type="radio"/> A <input type="radio"/> B <input type="radio"/> C <input type="radio"/> D <input type="radio"/> E
4 <input type="radio"/> A <input type="radio"/> B <input type="radio"/> C <input type="radio"/> D <input type="radio"/> E	24 <input type="radio"/> A <input type="radio"/> B <input type="radio"/> C <input type="radio"/> D <input type="radio"/> E	44 <input type="radio"/> A <input type="radio"/> B <input type="radio"/> C <input type="radio"/> D <input type="radio"/> E	64 <input type="radio"/> A <input type="radio"/> B <input type="radio"/> C <input type="radio"/> D <input type="radio"/> E	84 <input type="radio"/> A <input type="radio"/> B <input type="radio"/> C <input type="radio"/> D <input type="radio"/> E
5 <input type="radio"/> A <input type="radio"/> B <input type="radio"/> C <input type="radio"/> D <input type="radio"/> E	25 <input type="radio"/> A <input type="radio"/> B <input type="radio"/> C <input type="radio"/> D <input type="radio"/> E	45 <input type="radio"/> A <input type="radio"/> B <input type="radio"/> C <input type="radio"/> D <input type="radio"/> E	65 <input type="radio"/> A <input type="radio"/> B <input type="radio"/> C <input type="radio"/> D <input type="radio"/> E	85 <input type="radio"/> A <input type="radio"/> B <input type="radio"/> C <input type="radio"/> D <input type="radio"/> E
6 <input type="radio"/> A <input type="radio"/> B <input type="radio"/> C <input type="radio"/> D <input type="radio"/> E	26 <input type="radio"/> A <input type="radio"/> B <input type="radio"/> C <input type="radio"/> D <input type="radio"/> E	46 <input type="radio"/> A <input type="radio"/> B <input type="radio"/> C <input type="radio"/> D <input type="radio"/> E	66 <input type="radio"/> A <input type="radio"/> B <input type="radio"/> C <input type="radio"/> D <input type="radio"/> E	86 <input type="radio"/> A <input type="radio"/> B <input type="radio"/> C <input type="radio"/> D <input type="radio"/> E
7 <input type="radio"/> A <input type="radio"/> B <input type="radio"/> C <input type="radio"/> D <input type="radio"/> E	27 <input type="radio"/> A <input type="radio"/> B <input type="radio"/> C <input type="radio"/> D <input type="radio"/> E	47 <input type="radio"/> A <input type="radio"/> B <input type="radio"/> C <input type="radio"/> D <input type="radio"/> E	67 <input type="radio"/> A <input type="radio"/> B <input type="radio"/> C <input type="radio"/> D <input type="radio"/> E	87 <input type="radio"/> A <input type="radio"/> B <input type="radio"/> C <input type="radio"/> D <input type="radio"/> E
8 <input type="radio"/> A <input type="radio"/> B <input type="radio"/> C <input type="radio"/> D <input type="radio"/> E	28 <input type="radio"/> A <input type="radio"/> B <input type="radio"/> C <input type="radio"/> D <input type="radio"/> E	48 <input type="radio"/> A <input type="radio"/> B <input type="radio"/> C <input type="radio"/> D <input type="radio"/> E	68 <input type="radio"/> A <input type="radio"/> B <input type="radio"/> C <input type="radio"/> D <input type="radio"/> E	88 <input type="radio"/> A <input type="radio"/> B <input type="radio"/> C <input type="radio"/> D <input type="radio"/> E
9 <input type="radio"/> A <input type="radio"/> B <input type="radio"/> C <input type="radio"/> D <input type="radio"/> E	29 <input type="radio"/> A <input type="radio"/> B <input type="radio"/> C <input type="radio"/> D <input type="radio"/> E	49 <input type="radio"/> A <input type="radio"/> B <input type="radio"/> C <input type="radio"/> D <input type="radio"/> E	69 <input type="radio"/> A <input type="radio"/> B <input type="radio"/> C <input type="radio"/> D <input type="radio"/> E	89 <input type="radio"/> A <input type="radio"/> B <input type="radio"/> C <input type="radio"/> D <input type="radio"/> E
10 <input type="radio"/> A <input type="radio"/> B <input type="radio"/> C <input type="radio"/> D <input type="radio"/> E	30 <input type="radio"/> A <input type="radio"/> B <input type="radio"/> C <input type="radio"/> D <input type="radio"/> E	50 <input type="radio"/> A <input type="radio"/> B <input type="radio"/> C <input type="radio"/> D <input type="radio"/> E	70 <input type="radio"/> A <input type="radio"/> B <input type="radio"/> C <input type="radio"/> D <input type="radio"/> E	90 <input type="radio"/> A <input type="radio"/> B <input type="radio"/> C <input type="radio"/> D <input type="radio"/> E
11 <input type="radio"/> A <input type="radio"/> B <input type="radio"/> C <input type="radio"/> D <input type="radio"/> E	31 <input type="radio"/> A <input type="radio"/> B <input type="radio"/> C <input type="radio"/> D <input type="radio"/> E	51 <input type="radio"/> A <input type="radio"/> B <input type="radio"/> C <input type="radio"/> D <input type="radio"/> E	71 <input type="radio"/> A <input type="radio"/> B <input type="radio"/> C <input type="radio"/> D <input type="radio"/> E	91 <input type="radio"/> A <input type="radio"/> B <input type="radio"/> C <input type="radio"/> D <input type="radio"/> E
12 <input type="radio"/> A <input type="radio"/> B <input type="radio"/> C <input type="radio"/> D <input type="radio"/> E	32 <input type="radio"/> A <input type="radio"/> B <input type="radio"/> C <input type="radio"/> D <input type="radio"/> E	52 <input type="radio"/> A <input type="radio"/> B <input type="radio"/> C <input type="radio"/> D <input type="radio"/> E	72 <input type="radio"/> A <input type="radio"/> B <input type="radio"/> C <input type="radio"/> D <input type="radio"/> E	92 <input type="radio"/> A <input type="radio"/> B <input type="radio"/> C <input type="radio"/> D <input type="radio"/> E
13 <input type="radio"/> A <input type="radio"/> B <input type="radio"/> C <input type="radio"/> D <input type="radio"/> E	33 <input type="radio"/> A <input type="radio"/> B <input type="radio"/> C <input type="radio"/> D <input type="radio"/> E	53 <input type="radio"/> A <input type="radio"/> B <input type="radio"/> C <input type="radio"/> D <input type="radio"/> E	73 <input type="radio"/> A <input type="radio"/> B <input type="radio"/> C <input type="radio"/> D <input type="radio"/> E	93 <input type="radio"/> A <input type="radio"/> B <input type="radio"/> C <input type="radio"/> D <input type="radio"/> E
14 <input type="radio"/> A <input type="radio"/> B <input type="radio"/> C <input type="radio"/> D <input type="radio"/> E	34 <input type="radio"/> A <input type="radio"/> B <input type="radio"/> C <input type="radio"/> D <input type="radio"/> E	54 <input type="radio"/> A <input type="radio"/> B <input type="radio"/> C <input type="radio"/> D <input type="radio"/> E	74 <input type="radio"/> A <input type="radio"/> B <input type="radio"/> C <input type="radio"/> D <input type="radio"/> E	94 <input type="radio"/> A <input type="radio"/> B <input type="radio"/> C <input type="radio"/> D <input type="radio"/> E
15 <input type="radio"/> A <input type="radio"/> B <input type="radio"/> C <input type="radio"/> D <input type="radio"/> E	35 <input type="radio"/> A <input type="radio"/> B <input type="radio"/> C <input type="radio"/> D <input type="radio"/> E	55 <input type="radio"/> A <input type="radio"/> B <input type="radio"/> C <input type="radio"/> D <input type="radio"/> E	75 <input type="radio"/> A <input type="radio"/> B <input type="radio"/> C <input type="radio"/> D <input type="radio"/> E	95 <input type="radio"/> A <input type="radio"/> B <input type="radio"/> C <input type="radio"/> D <input type="radio"/> E
16 <input type="radio"/> A <input type="radio"/> B <input type="radio"/> C <input type="radio"/> D <input type="radio"/> E	36 <input type="radio"/> A <input type="radio"/> B <input type="radio"/> C <input type="radio"/> D <input type="radio"/> E	56 <input type="radio"/> A <input type="radio"/> B <input type="radio"/> C <input type="radio"/> D <input type="radio"/> E	76 <input type="radio"/> A <input type="radio"/> B <input type="radio"/> C <input type="radio"/> D <input type="radio"/> E	96 <input type="radio"/> A <input type="radio"/> B <input type="radio"/> C <input type="radio"/> D <input type="radio"/> E
17 <input type="radio"/> A <input type="radio"/> B <input type="radio"/> C <input type="radio"/> D <input type="radio"/> E	37 <input type="radio"/> A <input type="radio"/> B <input type="radio"/> C <input type="radio"/> D <input type="radio"/> E	57 <input type="radio"/> A <input type="radio"/> B <input type="radio"/> C <input type="radio"/> D <input type="radio"/> E	77 <input type="radio"/> A <input type="radio"/> B <input type="radio"/> C <input type="radio"/> D <input type="radio"/> E	97 <input type="radio"/> A <input type="radio"/> B <input type="radio"/> C <input type="radio"/> D <input type="radio"/> E
18 <input type="radio"/> A <input type="radio"/> B <input type="radio"/> C <input type="radio"/> D <input type="radio"/> E	38 <input type="radio"/> A <input type="radio"/> B <input type="radio"/> C <input type="radio"/> D <input type="radio"/> E	58 <input type="radio"/> A <input type="radio"/> B <input type="radio"/> C <input type="radio"/> D <input type="radio"/> E	78 <input type="radio"/> A <input type="radio"/> B <input type="radio"/> C <input type="radio"/> D <input type="radio"/> E	98 <input type="radio"/> A <input type="radio"/> B <input type="radio"/> C <input type="radio"/> D <input type="radio"/> E
19 <input type="radio"/> A <input type="radio"/> B <input type="radio"/> C <input type="radio"/> D <input type="radio"/> E	39 <input type="radio"/> A <input type="radio"/> B <input type="radio"/> C <input type="radio"/> D <input type="radio"/> E	59 <input type="radio"/> A <input type="radio"/> B <input type="radio"/> C <input type="radio"/> D <input type="radio"/> E	79 <input type="radio"/> A <input type="radio"/> B <input type="radio"/> C <input type="radio"/> D <input type="radio"/> E	99 <input type="radio"/> A <input type="radio"/> B <input type="radio"/> C <input type="radio"/> D <input type="radio"/> E
20 <input type="radio"/> A <input type="radio"/> B <input type="radio"/> C <input type="radio"/> D <input type="radio"/> E	40 <input type="radio"/> A <input type="radio"/> B <input type="radio"/> C <input type="radio"/> D <input type="radio"/> E	60 <input type="radio"/> A <input type="radio"/> B <input type="radio"/> C <input type="radio"/> D <input type="radio"/> E	80 <input type="radio"/> A <input type="radio"/> B <input type="radio"/> C <input type="radio"/> D <input type="radio"/> E	100 <input type="radio"/> A <input type="radio"/> B <input type="radio"/> C <input type="radio"/> D <input type="radio"/> E



ENLACE	DETALLE	QR
http://www.multimevi.com/	Página web MULTIMEVI, donde encontrarás noticias y recursos	
https://t.me/+Klr3YaM42_ZhZTIx	Grupo de apoyo en TELEGRAM	
https://chat.whatsapp.com/IQuCCcZjtLjIkLfgzXo68Y	<u>GRUPO DE WHATSAPP</u>	
https://whatsapp.com/channel/0029VaBB2zQHwXb5Vhn9Yw1W	Canal de noticias WhatsApp	
https://www.facebook.com/multimevi.ec/	Perfil de facebook	
https://www.facebook.com/groups/multimevi	Grupo FULL Rectivos	
https://www.tiktok.com/@multimevi	Canal de TIK TOK	
https://www.instagram.com/multimevi.ec/	Canal de Instagram	
https://twitter.com/multimevi	Red X	



Plataforma MOODLE

 www.riolearning.com

Página Web



www.multimevi.com

Redes Sociales



Procesos



ACCESO a la Educación Superior
SENESCYT

QUIERO SER MAESTRO
Ministerio de Educación